



# Omni XLT Series Telescopes

## INSTRUCTION MANUAL

• *Omni XLT 102* • *Omni XLT 120* • *Omni XLT 150* • *Omni XLT127*

# Table of Contents

<b>INTRODUCTION .....</b>	<b>4</b>
Warning .....	4
<b>ASSEMBLY .....</b>	<b>8</b>
Setting up the Tripod .....	8
Attaching the Equatorial Mount .....	9
Attaching the Center Leg Brace .....	10
Installing the Counterweight Bar.....	10
Installing the Counterweights.....	11
Attaching the Slow Motion Knobs .....	11
Attaching the Telescope Tube to the Mount.....	12
Installing the Finderscope.....	13
Installing the Visual Back.....	13
Installing the Star Diagonal .....	14
Installing the Eyepieces.....	14
Moving the Telescope Manually .....	15
Balancing the Mount in R.A.....	15
Balancing the Mount in DEC .....	16
Adjusting the Mount.....	16
Adjusting the Mount in Altitude.....	17
Adjusting the Mount in Azimuth.....	17
<b>TELESCOPE BASICS .....</b>	<b>18</b>
Image Orientation .....	20
Focusing .....	20
Aligning the Finderscope .....	21
Calculating Magnification .....	21
Determining Field of View.....	22
General Observing Hints .....	22
<b>ASTRONOMY BASICS.....</b>	<b>23</b>
The Celestial Coordinate System .....	23
Motion of the Stars .....	24
Latitude Scale .....	25
Pointing at Polaris .....	25
Finding the North Celestial Pole .....	26
Declination Drift Method of Polar Alignment.....	27
Aligning the R.A. Setting Circle .....	28
Using the R.A. Vernier Scale .....	29
<b>CELESTIAL OBSERVING.....</b>	<b>30</b>
Observing the Moon.....	30
Lunar Observing Hints .....	30
Observing the Planets .....	30
Observing the Sun .....	31
Solar Observing Hints .....	31
Observing Deep Sky Objects.....	31
Seeing Conditions.....	31
Transparency .....	31
Sky Illumination .....	31
Seeing .....	32

Using the Lens Cap Aperture Stop with Refractor Telescopes .....	32
<b>ASTROPHOTOGRAPHY .....</b>	<b>33</b>
Piggyback Photography .....	33
Short Exposure Prime Focus Photography for Refractors & Newtonians .....	34
Short Exposure Prime Focus Photography for Schmidt-Cassegrains .....	34
Eyepiece Projection for a Schmidt-Cassegrain .....	35
Long Exposure Prime Focus Photography .....	36
Planetary and Lunar Photography with Special Imagers .....	37
CCD Imaging for Deep Sky Objects .....	38
Terrestrial Photography .....	38
Metering .....	38
Reducing Vibration .....	38
<b>TELESCOPE MAINTENANCE .....</b>	<b>39</b>
Care and Cleaning of the Optics .....	39
Collimation of Refractors .....	39
Collimation of a Schmidt-Cassegrain .....	40
Collimation of a Newtonian .....	42
<b>OPTIONAL ACCESSORIES.....</b>	<b>46</b>
<b>APPENDIX A TECHNICAL SPECIFICATIONS .....</b>	<b>49</b>
<b>APPENDIX B - GLOSSARY OF TERMS.....</b>	<b>50</b>
<b>SKY MAPS.....</b>	<b>53</b>
<b>CELESTRON TWO YEAR WARRANTY .....</b>	<b>59</b>

# **Introduction**

Congratulations on your purchase of an Omni XLT Series telescope. The Omni XLT Series of telescopes come in several different models --- 102mm refractor, 120mm refractor, 150mm Newtonian, 127mm Schmidt-Cassegrain. The Omni Series is made of the highest quality materials to ensure stability and durability. All this adds up to a telescope that gives you a lifetime of pleasure with a minimal amount of maintenance. Furthermore, your Celestron telescope is versatile — it will grow as your interest grows. This instruction manual covers all the different models of the Omni XLT telescopes.

No matter at what level you are starting out, the Omni XLT Series telescopes will unfold for you and your friends all the wonders of the Universe.

Some of the many standard features of the Omni XLT include:

- Hand selected optical glass and hand figured optics resulting in superior images.
- Premium Celestron Starbright XLT optical coatings that provide maximum contrast and image sharpness.
- Heavy-duty equatorial mount with a rugged and very stable stainless steel tripod.
- Ball bearings in both axes of the mount ensure smooth performance.
- CD-ROM “The Sky” --- astronomy software which provides education about the sky and printable sky maps.

Many other high performance features!

The Omni XLT deluxe features combined with Celestron’s legendary optical systems give amateur astronomers the most sophisticated and easy to use telescopes available on the market today.

Take time to read through this manual before embarking on your journey through the Universe. It may take a few observing sessions to become familiar with your telescope, so you should keep this manual handy until you have fully mastered your telescope’s operation. The manual gives detailed information regarding each step as well as needed reference material and helpful hints guaranteed to make your observing experience as simple and pleasurable as possible.

Your telescope is designed to give you years of fun and rewarding observations. However, there are a few things to consider before using your telescope that will ensure your safety and protect your equipment.

## **Warning**



- ❑ **Never look directly at the sun with the naked eye or with a telescope (unless you have the proper solar filter). Permanent and irreversible eye damage may result.**
- ❑ Never use your telescope to project an image of the sun onto any surface. Internal heat build-up can damage the telescope and any accessories attached to it.
- ❑ Never use an eyepiece solar filter or a Herschel wedge. Internal heat build-up inside the telescope can cause these devices to crack or break, allowing unfiltered sunlight to pass through to the eye.

Never leave the telescope unsupervised, either when children are present or adults who may not be familiar with the correct operating procedures of your telescope.

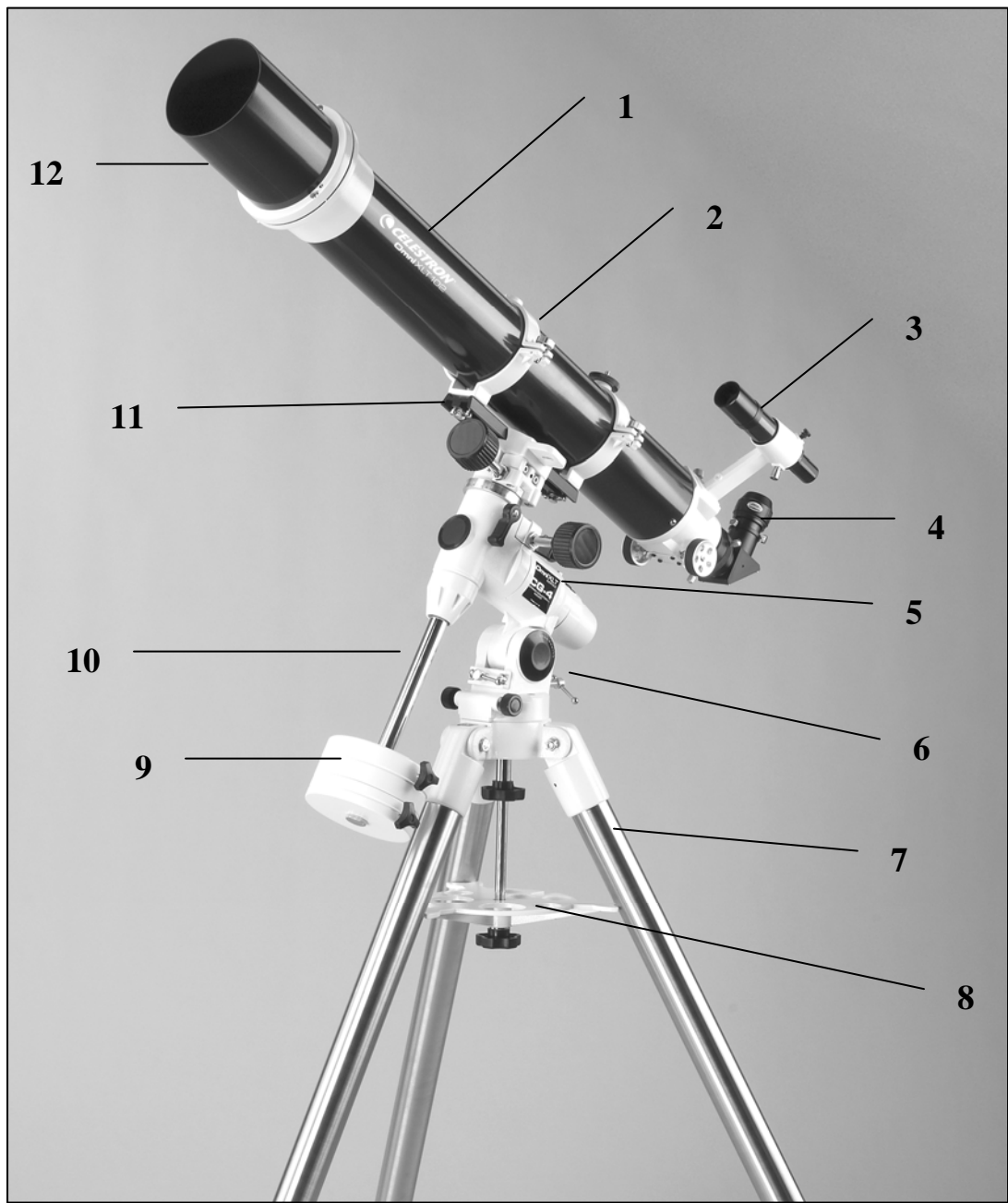

**Figure 1-1 Omni XLT 102 Refractor**  
 (Omni XLT 120 Refractor similar)

1.	Optical Tube	7.	1.75" Steel Tripod
2.	Tube Rings	8.	Accessory Tray/ Leg Brace
3.	Finderscope	9.	Counterweights
4.	Eyepiece	10.	Counterweight Bar
5.	Equatorial Mount	11.	Dovetail Slide Bar
6.	Latitude Adjustment Screw	12.	Objective Lens Shade

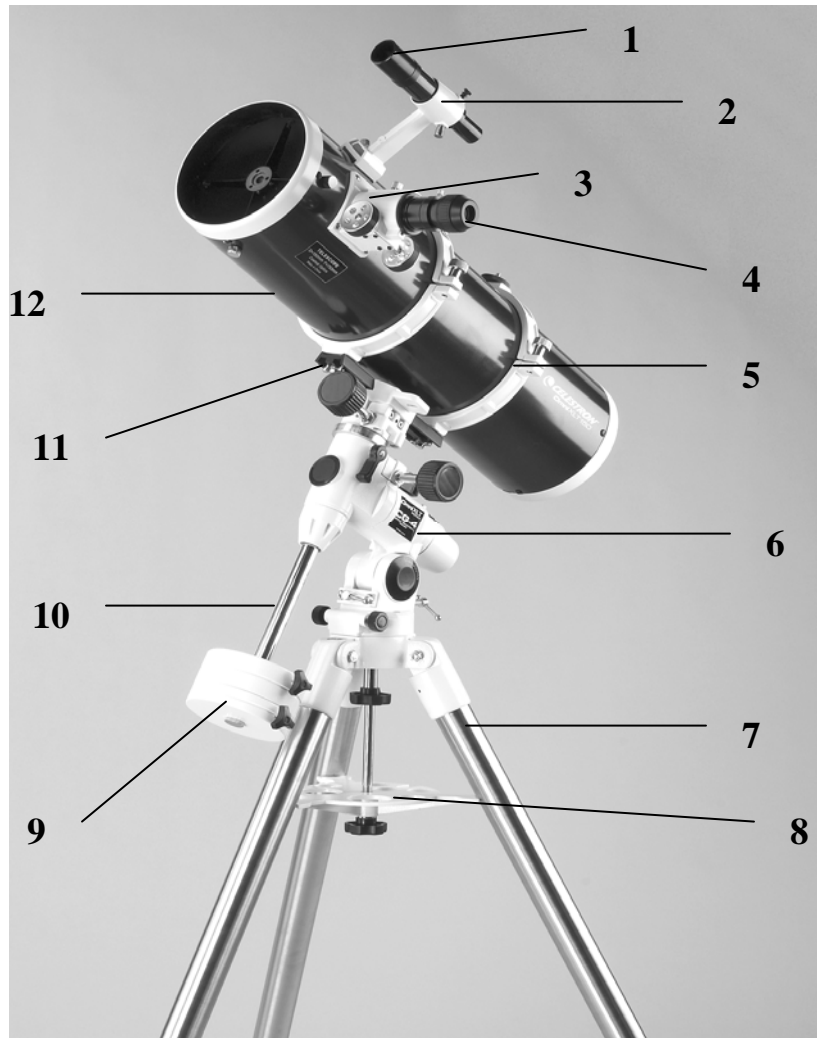

**Figure 1-2 Omni XLT 150 Newtonian**

<b>1.</b>	<b>Finderscope</b>	<b>7.</b>	<b>1.75" Steel Tripod</b>
<b>2.</b>	<b>Finderscope Bracket</b>	<b>8.</b>	<b>Accessory Tray/ Leg Brace</b>
<b>3.</b>	<b>Focuser</b>	<b>9.</b>	<b>Counterweights</b>
<b>4.</b>	<b>Eyepiece</b>	<b>10.</b>	<b>Counterweight Bar</b>
<b>5.</b>	<b>Tube Rings</b>	<b>11.</b>	<b>Dovetail Slide Bar</b>
<b>6.</b>	<b>Equatorial Mount</b>	<b>12.</b>	<b>Optical Tube</b>

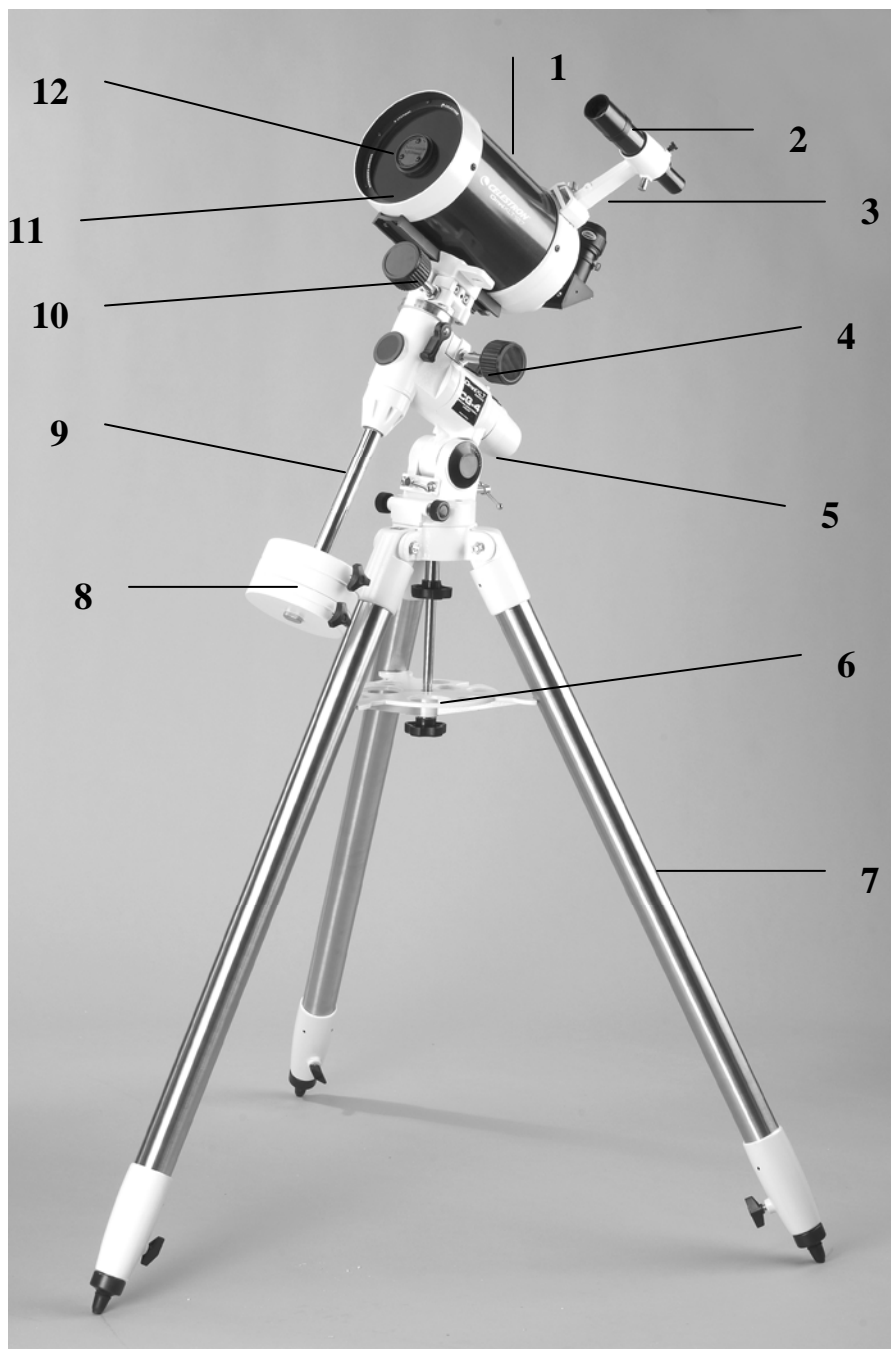

**Figure 1-3 Omni XLT 127 Schmidt-Cassegrain**

1.	Optical Tube	7.	1.75" Steel Tripod
2.	Finderscope	8.	Counterweights
3.	Finderscope Bracket	9.	Counterweight Bar
4.	Equatorial Mount	10.	Declination Setting Circle
5.	Latitude Scale	11.	Dovetail Slide Bar
6.	Accessory Tray/ Leg Brace	12.	Schmidt Corrector Lens

# 

This section covers the assembly instructions for your Celestron Omni XLT telescope. The equatorial mount is exactly the same for all the Omni telescope models and the optical tubes have some differences which will be noted. Your Omni telescope should be set up indoors the first time so that it is easy to identify the various parts and familiarize yourself with the correct assembly procedure before attempting it outdoor.

Each Omni telescopes comes in two boxes. One box contains the tripod, tripod accessory tray/brace, equatorial mount, counterweight bar, two counterweights, r.a. knob, dec. knob, polar axis polar cap, and a Phillips head screwdriver. The second box contains the telescope optical tube assembly, finderscope and bracket, eyepiece, and other standard accessory items per the specific model that you have.

## **Setting up the Tripod**

Remove the tripod from the box that it is in (Figure 2-1). The Omni tripod comes with an all metal center leg brace / accessory tray to give rock solid support to the mount. The tripod comes fully assembled with a metal plate, called the tripod head, that holds the legs together at the top. In addition, there is a central rod that extends down from the tripod head that attaches the equatorial mount to the tripod. To set up the tripod:

1. Stand the tripod upright and pull the tripod legs apart until each leg is fully extended. The tripod will now stand by itself (Figure 2-2). Once the tripod is set up, you can adjust the height at which it stands.
2. Loosen the lever (turn counterclockwise) on the leg clamp so that the tripod leg can be adjusted (Figure 2-3).
3. Slide the center portion of the tripod leg away from the tripod head until it is at the desired height.
4. Tighten the levers (turn clockwise) on each leg clamp to hold the legs in place.
5. The standard height of the tripod is 33" and it can be extended at any height up to a maximum of 47". Remember that the tripod will be the most rigid and stable at the lowest height.



**Figure 2-1**



**Figure 2-2**



**Figure 2-3**



## Attaching the Equatorial Mount

The equatorial mount allows you to tilt the telescope's axis of rotation so that you can track the stars as they move across the sky. The Omni mount is a German equatorial mount that attaches to the tripod head. On one side of the tripod head there is a metal alignment peg for aligning the mount. This side of the tripod will face north when setting up for an astronomical observing session. To attach the equatorial head:

1. Locate the azimuth adjustment screws on the equatorial mount (see Figure 2-4).
2. Retract the screws so they no longer extend into the azimuth housing on the mount. **Do NOT remove the screws since they are needed later for polar alignment.**
3. Hold the equatorial mount over the tripod head so that the azimuth housing is above the metal peg.
4. Place the equatorial mount on the tripod head so that the two are flush. You can rotate the mount slightly but the center position (where the front latitude adjustment screw is directly over the "N" on the tripod). Then tighten the azimuth adjustment screws.
5. Tighten the mounting knob (attached to the central rod) on the underside of the tripod head to hold the equatorial mount firmly in place.



Figure 2-4

Equatorial Mount

Azimuth Adjustment Screws

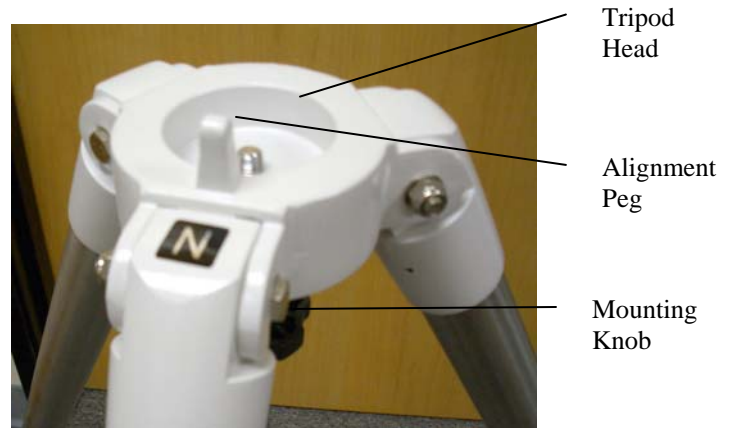

Figure 2-5

Tripod Head

Alignment Peg

Mounting Knob

## Attaching the Center Leg Brace

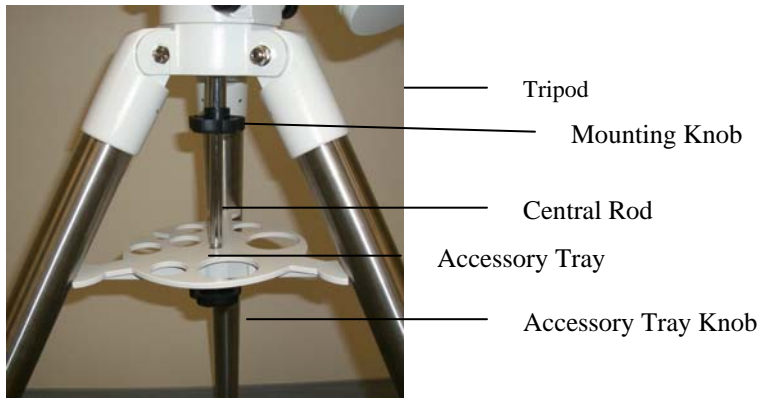

Exhibit 2-6

1. Remove the accessory tray knob and washer from the central rod.
2. Slide the accessory tray over the central rod so that each arm of the tray is pushing against the inside of the tripod legs.
3. Thread the accessory tray knob onto the central rod and tighten.

## Installing the Counterweight Bar

To properly balance the telescope, the mount comes with a counterweight bar and two counterweights. To install the counterweight bar:

1. Remove the counterweight safety screw from the counterweight bar (at the opposite end of the threaded end).
2. Thread the counterweight bar through the counterweight bar locking nut.
3. Locate the opening in the equatorial mount on the DEC axis.
4. Thread the counterweight bar into the opening until tight.
5. Tighten the counterweight bar lock nut fully for added support (see fig 2-7).

Once the bar is securely in place you are ready to attach the counterweights.

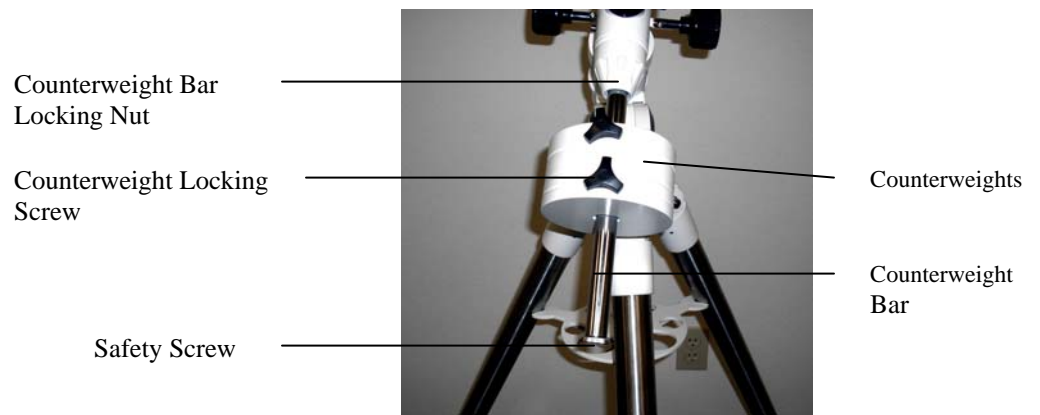

Figure 2-7

Since the fully assembled telescope can be quite heavy, position the mount so that the polar axis is pointing towards north before the tube assembly and counterweights are attached. This will make the polar alignment procedure much easier.

## ***Installing the Counterweights***

Each Omni mount comes with two counterweights (One weights lbs. and the other weights 4 lbs.) To install the counterweight(s):

1. Orient the mount so that the counterweight bar points toward the ground.
2. Loosen the locking screw on the side of the counterweights (it doesn't matter which counterweight you attach first) so that the threads do not protrude through the center hole of the counterweight.
3. Slide the counterweight onto the shaft (see Figure 2-7).
4. Tighten the locking screw on the side of the weight to hold the counterweight in place.
5. Slide the second counterweight onto the shaft and tighten as in # 4.
6. Replace the counterweight safety screw.

## ***Attaching the Slow Motion Knobs***

The Omni mount comes with two slow motion control knobs that allows you to make fine pointing adjustments to the telescope in both R.A. and Declination. To install the knobs:

1. Locate the two knobs (both are identical) and make sure the screw on each knob does not protrude through the knob shaft opening. Use the supplied Phillips head screwdriver.
2. Line up the flat area on the inner portion of the R.A. slow motion knob with the flat area on the R.A. shaft (see Fig 2-8).
3. Slide the R.A. slow motion knob onto the R.A. shaft. There are two R.A. shafts, one on either side of the mount. It makes no difference which shaft you use since both work the same. Use whichever one you find more convenient. If, If after a few observing sessions, you find the R.A. slow motion knob is more accessible from the other side, reinstall it on the opposite side.
4. Tighten the screw on the R.A. knob to hold it securely in place.

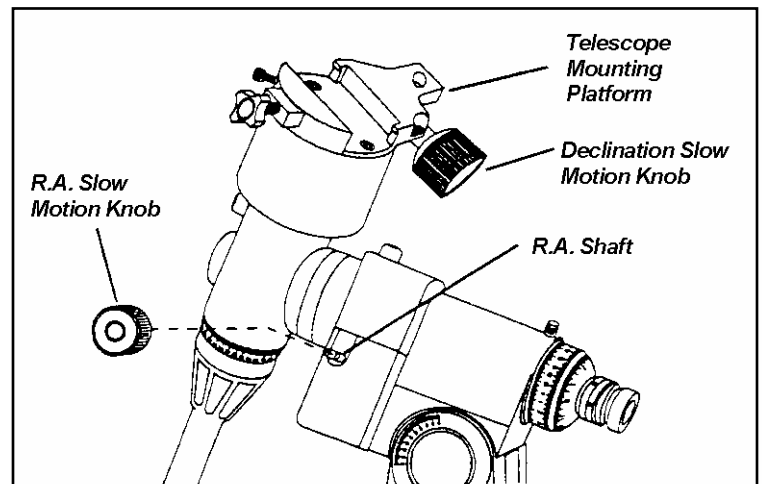

**Figure 2-8**

5. The DEC slow motion knob attaches in the same manner as the R.A. knob. The shaft that the DEC slow motion knob fits over is toward the top of the mount, just below the telescope mounting platform. Once again, you have two shafts to choose from. Use the shaft that is pointing toward the ground. This makes it easy to reach while looking through the telescope, something which is quite important when you are observing but again if it is more convenient for you to use, then reinstall the knob that best suits your needs.

6. Put the polar axis cap over the polar axis. It is held into place by a tension fit.

## ***Attaching the Telescope Tube to the Mount***

The telescope optical tube attaches to the mount via a dovetail slide bar mounting bracket. For the refractors and the Newtonian, the mounting bracket is the long bracket which is attached to the tube rings. For the Schmidt-Cassegrain the mounting bracket is attached along the bottom of the telescope tube. **Before you attach the optical tube, make sure that the declination and right ascension clutch knobs (clamps) are tight.** This will ensure that the mount does not move suddenly while attaching the telescope optical tube. To mount the telescope tube:

1 Remove the protective paper covering the optical tube. You will have to remove the tube rings on the refractors and Newtonian before removing the paper.

2 Loosen the mounting knob and the mounting safety screw on the side of the mount platform so they do not protrude into the mounting platform

3. Slide the dovetail mounting bracket into the recess on the top of the mounting platform (see figure 2-9).

5 Tighten the mounting knob on the Omni mounting platform to hold the telescope in place.

6 Hand tighten the mounting platform safety screw until the tip touches the side of the mounting bracket.

**NOTE: Never loosen any of the knobs on the telescope tube or mount other than the R.A. and DEC knobs.**

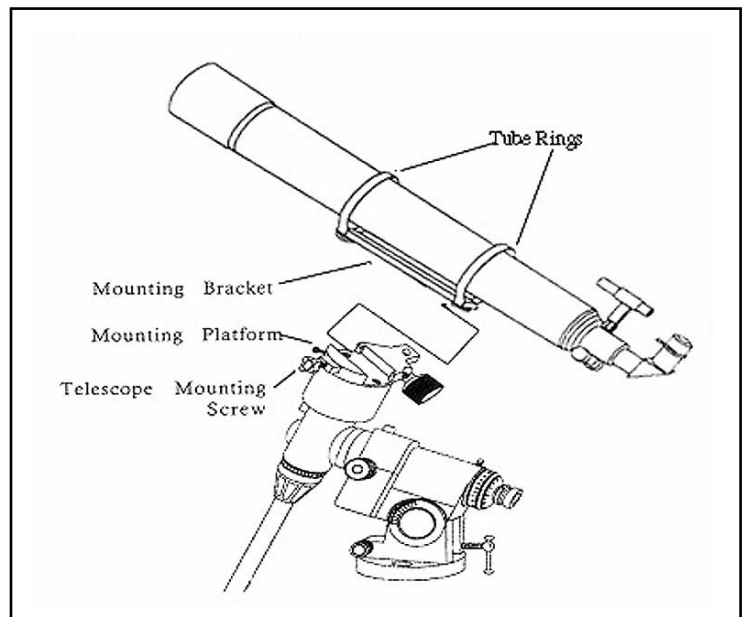

**Figure 2-9** Refractor Optical Tube is shown. The Newtonian and Schmidt-Cassegrain attach similarly.

## Installing the Finderscope

To install the finderscope onto the telescope you must first mount the finderscope through the finder bracket and then attach it to the telescope. Toward the rear of the telescope tube (on refractors and Schmidt-Cassegrain) and front of the telescope tube (Newtonian), there is a small bracket with a set screw in it. This is where the finderscope bracket will be mounted. To install the finderscope:

1. Loosen the finderscope adjustment screws so they don't protrude into the bracket. Then slide the rubber O-ring over the eyepiece end of the finderscope (smallest diameter side) and roll it 2/3 of the way up into the slot (groove) in the finderscope.
2. Insert the eyepiece end of the finderscope through the narrow part of the bracket until the O-ring presses tightly between the finder and the inside of the bracket. Once it stops, then pull outward on the spring loaded adjustment screw and continue inserting the finderscope until it is approximately centered in the bracket.
3. Tighten the two adjustment screws until they make contact with the finderscope body.

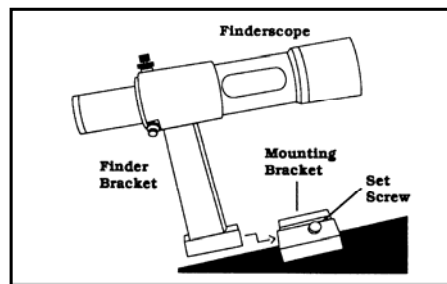

Figure 2-10

4. Locate the mounting bracket near the front (open) end of the telescope.
5. Loosen the set screw on the mounting bracket on the telescope so it does not protrude into the bracket.
6. Slide the finder bracket (attached to the finderscope) into the mounting bracket on the telescope.
7. The finderscope bracket will slide in from the back. The finderscope should be oriented so that the objective lens is toward the front (open) end of the telescope.
8. Tighten the set screw on the mounting bracket to hold the finderscope in place.

For information on aligning your finderscope, see *Telescope Basics* section of this manual.

## Installing the Visual Back

Only applicable to the Schmidt-Cassegrain, the visual back is the accessory that allows you to attach all visual accessories to the telescope. The Omni Schmidt-Cassegrain normally comes with the visual back installed. If in case it is not installed, follow these instructions for attaching it:

1. Remove the cover on the rear cell and then place the knurled slip ring on the visual back over the threads on the rear cell (Fig 2-11).
2. Hold the visual back with the set screw in a convenient position and rotate the knurled slip ring clockwise until tight. Once this is done, you are ready to attach other accessories, such as diagonals (for refractors and the Schmidt-Cassegrain), eyepieces, etc. If you want to remove the visual back, rotate the slip ring counterclockwise until it is free of the rear cell.

## Installing the Star Diagonal

The star diagonal is a prism that diverts the light at a right angle to the light path of refractors and Schmidt-Cassegrain telescopes. This allows you to observe in positions that are physically more comfortable than if you looked straight through. To attach the star diagonal onto the optical tube of a Schmidt-Cassegrain:

1. Turn the set screw on the visual back until its tip no longer extends into (i.e., obstructs) the inner diameter of the visual back.
2. Slide the chrome portion of the star diagonal into the visual back.
3. Tighten the set screw on the visual back to hold the star diagonal in place.

If you wish to change the orientation of the star diagonal, loosen the set screw on the visual back until the star diagonal rotates freely. Rotate the diagonal to the desired position and tighten the set screw.

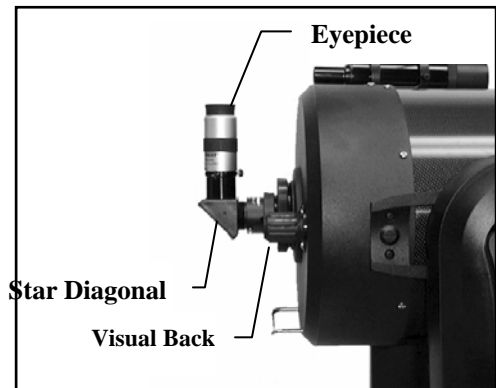

Figure 2-11

**Refractors** – To use the star diagonal on refractor telescopes, it is inserted into the 1 ¼” eyepiece adapter.

## Installing the Eyepieces

The eyepiece, or ocular as it is also called, is an optical element that magnifies the image focused by the telescope. Without the eyepiece it would be impossible to use the telescope visually. The eyepiece fits directly into the focuser of refractors and the Newtonian or into the visual back on the Schmidt-Cassegrain. To attach an ocular:

1. Loosen the set screw on the eyepiece adapter so that it does not obstruct the inner diameter of the barrel.
2. Slide the chrome portion of the eyepiece into the focuser.
3. Tighten the set screw to hold the eyepiece in place.

To remove the eyepiece, loosen the set screw on the focuser and slide the eyepiece out. You can replace it with another ocular.

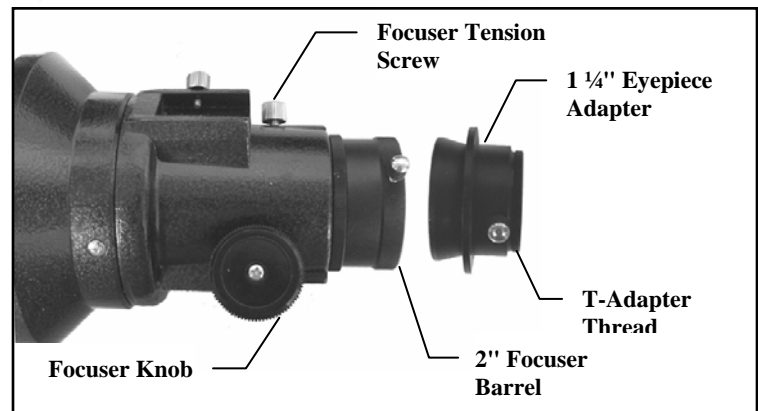

Figure 2-12

Many times it will be more comfortable to use a star diagonal on the refractors and Schmidt-Cassegrain for most areas of the sky. To install an eyepiece into the star diagonal:

- A. Loosen the set screw on the star diagonal until the tip no longer extends into the inner diameter of the eyepiece end of the diagonal.
- B. Slide the chrome portion of the eyepiece into the star diagonal.
- C. Tighten the set screw on the star diagonal to hold the eyepiece in place.
- D. To remove the eyepiece, loosen the set screw on the star diagonal and slide the eyepiece out. You can replace it with other optional eyepieces.

The refracting telescopes can use eyepieces and diagonals of a 2" barrel diameter. To use a 2" barrel eyepiece, the 1 1/4" eyepiece adapter must first be removed. To do this, simply loosen the two chrome thumbscrews located around the focuser barrel (see figure 2-12) and remove the 1 1/4" adapter. Once removed, a 2" eyepiece or accessory can be inserted directly into the focuser barrel and secured with the two thumb screws.

Eyepieces are commonly referred to by focal length and barrel diameter. The focal length of each eyepiece is printed on the eyepiece barrel. The longer the focal length (i.e., the larger the number) the lower the eyepiece magnification (i.e., power) and the shorter the focal length (i.e., the smaller the number) the higher the magnification. Generally, you will use low-to-moderate power when viewing. For more information on how to determine power, see the section on "Calculating Magnification."

## ***Moving the Telescope Manually***

In order to properly balance your telescope, you will need to move your telescope manually at various portions of the sky to observe different objects. To make rough adjustments, loosen the R.A. and DEC clutch knobs slightly and move the telescope in the desired direction.

Both the R.A. and DEC axis have lock levers to clutch down each axis of the telescope. To loosen the clutches on the telescope, rotate the lock levers counterclockwise.

## ***Balancing the Mount in R.A.***

To eliminate undue stress on the mount, the telescope should be properly balanced around the polar axis. In addition, proper balancing is crucial for accurate tracking if using an optional motor drive. To balance the mount:

1. Release the R.A. Clamp (see figure 2-13) and position the telescope off to one side of the mount (make sure that the mounting bracket screw is tight). The counterweight bar will extend horizontally on the opposite side of the mount (see figure 2-12).
2. Release the telescope — **GRADUALLY** — to see which way the telescope "rolls."
3. Loosen the counterweight locking screw on the counterweight.
4. Move the counterweights to a point where they balance the telescope (i.e., it remains stationary when the R.A. clamp is released).
5. Tighten the locking screw to hold the counterweights in place.

**These are general balance instructions and will reduce undue stress on the mount. When taking astrophotographs, this balance process should be done for the specific area at which the telescope is pointing.**

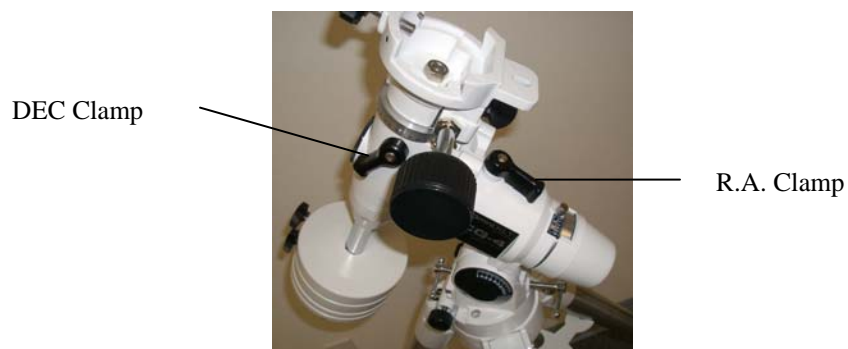

**Figure 2-13**

## Balancing the Mount in DEC

The telescope should also be balanced on the declination axis to prevent any sudden motions when the DEC clamp (Fig 2-13) is released. To balance the telescope in DEC:

1. Release the R.A. clamp and rotate the telescope so that it is on one side of the mount (i.e., as described in the previous section on balancing the telescope in R.A.).
2. Lock the R.A. clamp to hold the telescope in place.
3. Release the DEC clamp and rotate the telescope until the tube is parallel to the ground (see figure 2-15).
4. Release the tube — **GRADUALLY** — to see which way it rotates around the declination axis. **DO NOT LET GO OF THE TELESCOPE TUBE COMPLETELY!**
5. Loosen the screws that hold the telescope tube inside the mounting rings and slide the telescope either forwards or backwards until it remains stationary when the DEC clamp is released.
6. Tighten the tube ring screws firmly to hold the telescope in place.

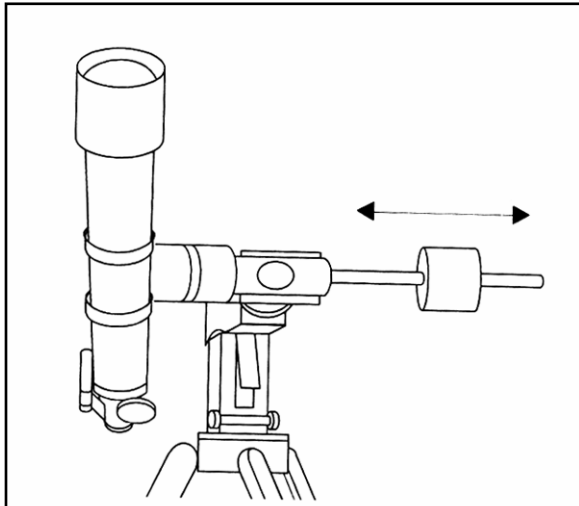

Figure 2-14

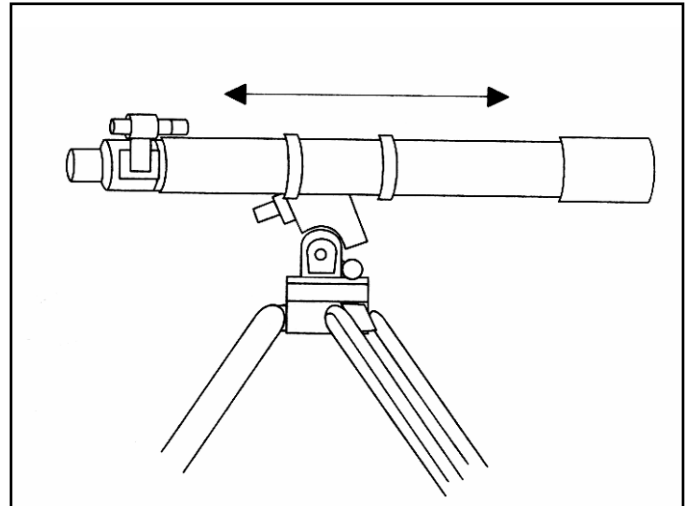

Figure 2-15

**Like the R.A. balance, these are general balance instructions and will reduce undue stress on the mount. When taking astrophotographs, this balance process should be done for the specific area at which the telescope is pointing.**

## Adjusting the Mount

In order for a motor drive to track accurately, the telescope's axis of rotation must be parallel to the Earth's axis of rotation, a process known as polar alignment. Polar alignment is achieved NOT by moving the telescope in R.A. or DEC, but by adjusting the mount vertically, which is called altitude, and horizontally, which is called azimuth. This section simply covers the correct movement of the telescope during the polar alignment process. The actual process of polar alignment, that is making the telescope's axis of rotation parallel to the Earth's, is described later in this manual in the section on "Polar Alignment."



## ***Adjusting the Mount in Altitude***

- To increase the latitude of the polar axis, tighten the rear latitude adjustment screw and loosen the front screw (if necessary).
- To decrease the latitude of the polar axis, tighten the front (under the counterweight bar) latitude adjustment screw and loosen the rear screw (if necessary).

The latitude adjustment on the Omni mount has a range from approximately 20° going up to 60°.

It is best to always make final adjustments in altitude by moving the mount against gravity (i.e. using the rear latitude adjustment screw to raise the mount). To do this you should loosen both latitude adjustment screws and manually push the front of the mount down as far as it will go. Then tighten the rear adjustment screw to raise the mount to the desired latitude.



**Figure 2-16**

## ***Adjusting the Mount in Azimuth***

For rough adjustments in azimuth, simply pick up the telescope and tripod and move it. For fine adjustments in azimuth:

1. Turn the azimuth adjustment knobs located on either side of the azimuth housing (see Fig 2-14). While standing behind the telescope, the knobs are on the front of the mount.
  - Turning the right adjustment knob clockwise moves the mount toward the right.
  - Turning the left adjustment knob clockwise moves the mount to the left.

Both screws push off of the peg on the tripod head, which means you may have to loosen one screw while tightening the other. The screw that holds the equatorial mount to the tripod may have to be loosened slightly.

Keep in mind that adjusting the mount is done during the polar alignment process only. Once polar aligned, the mount must NOT be moved. Pointing the telescope is done by moving the mount in right ascension and declination, as described earlier in this manual.



# Telescope Basics

A telescope is an instrument that collects and focuses light. The nature of the optical design determines how the light is focused. Some telescopes, known as refractors, use lenses. Other telescopes, known as reflectors (Newtonians), use mirrors. Then, the Schmidt-Cassegrain telescope uses both mirrors and lenses. Each optical design is briefly discussed below:

Developed in the early 1600s, the **refractor** is the oldest telescope design. It derives its name from the method it uses to focus incoming light rays. The refractor uses a lens to bend or refract incoming light rays, hence the name (see Figure 4-1). Early designs used single element lenses. However, the single lens acts like a prism and breaks light down into the colors of the rainbow, a phenomenon known as chromatic aberration. To get around this problem, a two-element lens, known as an achromat, was introduced. Each element has a different index of refraction allowing two different wavelengths of light to be focused at the same point. Most two-element lenses, usually made of crown and flint glasses, are corrected for red and green light. Blue light may still be focused at a slightly different point.

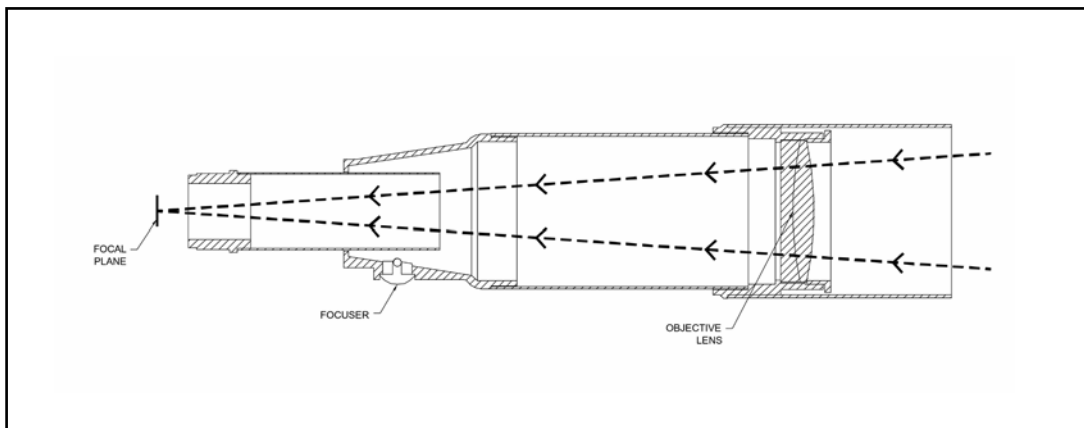

**Figure 3-1**  
*A cutaway view of the light path of the Refractor optical design*

A **Newtonian** reflector uses a single concave mirror as its primary. Light enters the tube traveling to the mirror at the back end. There light is bent forward in the tube to a single point, its focal point. Since putting your head in front of the telescope to look at the image with an eyepiece would keep the reflector from working, a flat mirror called a *diagonal* intercepts the light and points it out the side of the tube at right angles to the tube. The eyepiece is placed there for easy viewing.

Newtonian Reflector telescopes replace heavy lenses with mirrors to collect and focus the light, providing much more light-gathering power for the dollar. Because the light path is intercepted and reflected out to the side, you can have focal lengths up to 1000mm and still enjoy a telescope that is relatively compact and portable. A Newtonian Reflector telescope offers such impressive light-gathering characteristics you can take a serious interest in deep space astronomy even on a modest budget. Newtonian Reflector telescopes do require more care and maintenance because the primary mirror is exposed to air and dust. However, this small drawback does not hamper this type of telescope's popularity with those who want an economical telescope that can still resolve faint, distant objects.

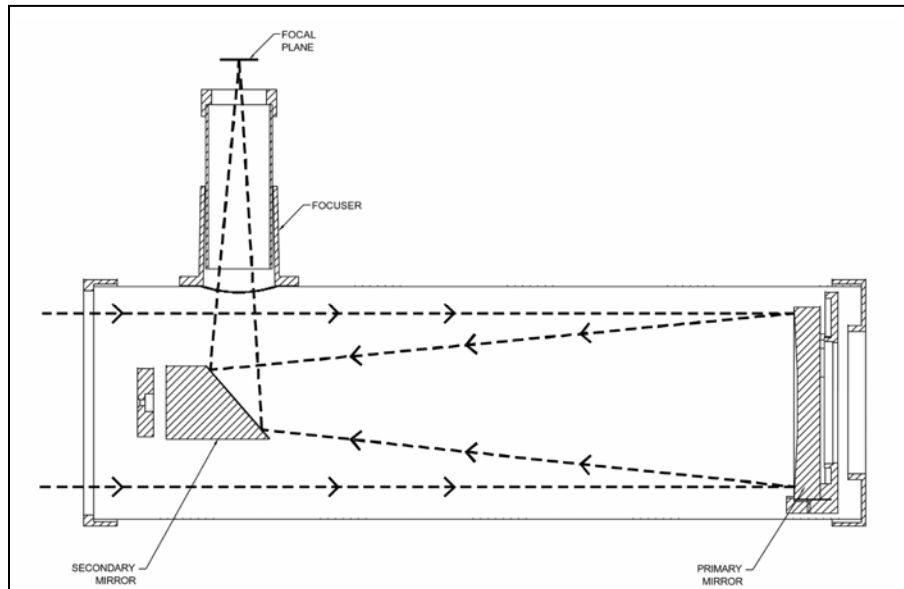
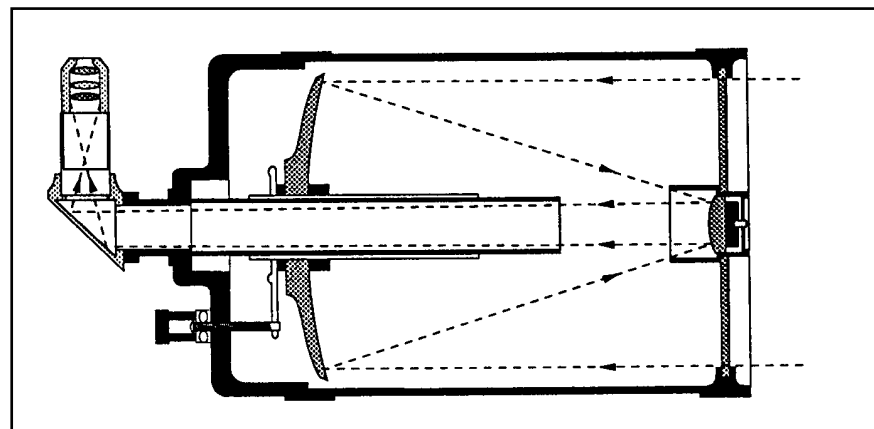

**Figure 3-2**  
*A cutaway view of the light path of the Newtonian optical design*

The **Schmidt-Cassegrain** optical system (or Schmidt-Cass for short) uses a combination of mirrors and lenses and is referred to as a compound or catadioptric telescope. This unique design offers large-diameter optics while maintaining very short tube lengths, making them extremely portable. The Schmidt-Cassegrain system consists of a zero power corrector plate, a spherical primary mirror, and a secondary mirror. Once light rays enter the optical system, they travel the length of the optical tube three times.

The optics of the Advanced Series Schmidt-Cassegrain telescopes have Starbright coatings - enhanced multi-layer coatings on the primary and secondary mirrors for increased reflectivity and a fully coated corrector for the finest anti-reflection characteristics.

Inside the optical tube, a black tube extends out from the center hole in the primary mirror. This is the primary baffle tube and it prevents stray light from passing through to the eyepiece or camera.



**Figure 3-3**  
*A cutaway view of the light path of the Schmidt-Cassegrain optical design*

## Image Orientation

The image orientation changes depending on how the eyepiece is inserted into the telescope. When using the star diagonal with refractors and Schmidt-Cassegrains, the image is right-side-up, but reversed from left-to-right (i.e., mirror image). If inserting the eyepiece directly into the focuser of a refractor or the visual back of the Schmidt-Cassegrain (i.e., without the star diagonal), the image is upside-down and reversed from left-to-right (i.e., inverted).

Newtonian reflectors produce a right-side-up image but the image will appear rotated based on the location of the eyepiece holder in relation to the ground. Newtonian reflectors are best for astronomical use where right-side-up does not matter.



Figure 3-4

## Focusing

To focus your refractor or Newtonian telescope, simply turn the focus knob located directly below the eyepiece holder. Turning the knob clockwise allows you to focus on an object that is farther than the one you are currently observing. Turning the knob counterclockwise from you allows you to focus on an object closer than the one you are currently observing.

The Schmidt-Cassegrain focusing mechanism controls the primary mirror which is mounted on a ring that slides back and forth on the primary baffle tube. The focusing knob, which moves the primary mirror, is on the rear cell of the telescope just below the star diagonal and eyepiece. Turn the focusing knob until the image is sharp. If the knob will not turn, it has reached the end of its travel on the focusing mechanism. Turn the knob in the opposite direction until the image is sharp. Once an image is in focus, turn the knob clockwise to focus on a closer object and counterclockwise for a more distant object. A single turn of the focusing knob moves the primary mirror only slightly. Therefore, it will take many turns (about 30) to go from close focus (approximately 60 feet) to infinity.

For astronomical viewing, out of focus star images are very diffuse, making them difficult to see. If you turn the focus knob too quickly, you can go right through focus without seeing the image. To avoid this problem, your first astronomical target should be a bright object (like the Moon or a planet) so that the image is visible even when out of focus. Critical focusing is best accomplished when the focusing knob is turned in such a manner that the mirror moves against the pull of gravity. In doing so, any mirror shift is minimized. For astronomical observing, both visually and photographically, this is done by turning the focus knob counterclockwise.

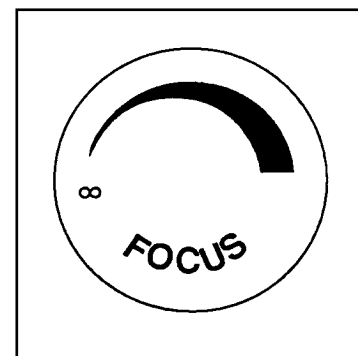

Figure 3-5  
The emblem on the end of the focus knob shows the correct rotational direction for focusing your telescope.

**Note:** If you wear corrective lenses (specifically glasses), you may want to remove them when observing with an eyepiece attached to the telescope. However, when using a camera you should always wear corrective lenses to ensure the sharpest possible focus. If you have astigmatism, corrective lenses must be worn at all times.

## ***Aligning the Finderscope***

Accurate alignment of the finder makes it easy to find objects with the telescope, especially celestial objects. To make aligning the finder as easy as possible, this procedure should be done in the daytime when it is easy to find and identify objects. The finderscope has a spring-loaded adjustment screw that puts pressure on the finderscope while the remaining screws are used to adjust the finder horizontally and vertically. To align the finder:

- 1 Choose a target that is in excess of one mile away. This eliminates any possible parallax effect between the telescope and finder.
- 2 Release the R.A. and DEC clamps and point the telescope at your target.
- 3 Center your target in the main optics of the telescope. You may have to move the telescope slightly to center it.
- 4 Adjust the screw on the finder bracket that is on the right (when looking through the finder) until the cross hairs are centered horizontally on the target seen through the telescope.
- 5 Adjust the screw on the top of the finder bracket until the cross hairs are centered vertically on the target seen through the telescope.

Image orientation through the finder is inverted (i.e., upside down and backwards left-to-right). This is normal for most astronomical finderscopes. Because of this, it may take a few minutes to familiarize yourself with the directional change each screw makes on the finder.

## ***Calculating Magnification***

You can change the power of your telescope just by changing the eyepiece (ocular). To determine the magnification of your telescope, simply divide the focal length of the telescope by the focal length of the eyepiece used. In equation format, the formula looks like this:

$$\text{Magnification} = \frac{\text{Focal Length of Telescope (mm)}}{\text{Focal Length of Eyepiece (mm)}}$$

Let's say, for example, you are using the 25mm eyepiece that came with your telescope. To determine the magnification you simply divide the focal length of your telescope (the Omni XLT 102 for this example has a focal length of 1000mm) by the focal length of the eyepiece, 25mm. Dividing 1000 by 25 yields a magnification of 40 power.

Although the power is variable, each instrument under average skies has a limit to the highest useful magnification. The general rule is that 60 power can be used for every inch of aperture. For example, the Omni XLT 102 is 4 inches in diameter. Multiplying 4 by 60 gives a maximum useful magnification of 240 power. Although this is the maximum useful magnification, most observing is done in the range of 20 to 35 power for every inch of aperture which is 80 to 140 times for the Omni XLT 102 telescope. You can determine the magnification for your telescope the same way.

## Determining Field of View

Determining the field of view is important if you want to get an idea of the angular size of the object you are observing. To calculate the actual field of view, divide the apparent field of the eyepiece (supplied by the eyepiece manufacturer) by the magnification. In equation format, the formula looks like this:

$$\text{True Field} = \frac{\text{Apparent Field of Eyepiece}}{\text{Magnification}}$$

As you can see, before determining the field of view, you must calculate the magnification. Using the example in the previous section, we can determine the field of view using the same 25mm eyepiece that is supplied standard with all Omni XLT telescopes. The 25mm eyepiece has an apparent field of view of 50°. Divide the 50° by the magnification, which is 40 power. This yields an actual field of 1.25°.

To convert degrees to feet at 1,000 yards, which is more useful for terrestrial observing, simply multiply by 52.5. Continuing with our example, multiply the angular field of 1.25° by 52.5. This produces a linear field width of 65.6 feet at a distance of one thousand yards. The apparent field of each eyepiece that Celestron manufactures is found in the Celestron Accessory Catalog (# 93685).

## General Observing Hints

When working with any optical instrument, there are a few things to remember to ensure you get the best possible image.

- Never look through window glass. Glass found in household windows is optically imperfect, and as a result, may vary in thickness from one part of a window to the next. This inconsistency can and will affect the ability to focus your telescope. In most cases you will not be able to achieve a truly sharp image, while in some cases, you may actually see a double image.
- Never look across or over objects that are producing heat waves. This includes asphalt parking lots on hot summer days or building rooftops.
- Hazy skies, fog, and mist can also make it difficult to focus when viewing terrestrially. The amount of detail seen under these conditions is greatly reduced. Also, when photographing under these conditions, the processed film may come out a little grainier than normal with lower contrast and underexposed.
- If you wear corrective lenses (specifically glasses), you may want to remove them when observing with an eyepiece attached to the telescope. When using a camera, however, you should always wear corrective lenses to ensure the sharpest possible focus. If you have astigmatism, corrective lenses must be worn at all times.

# **Astronomy Basics**

Up to this point, this manual covered the assembly and basic operation of your telescope. However, to understand your telescope more thoroughly, you need to know a little about the night sky. This section deals with observational astronomy in general and includes information on the night sky and polar alignment.

## **The Celestial Coordinate System**

To help find objects in the sky, astronomers use a celestial coordinate system that is similar to our geographical coordinate system here on Earth. The celestial coordinate system has poles, lines of longitude and latitude, and an equator. For the most part, these remain fixed against the background stars.

The celestial equator runs 360 degrees around the Earth and separates the northern celestial hemisphere from the southern. Like the Earth's equator, it bears a reading of zero degrees. On Earth this would be latitude. However, in the sky this is referred to as declination, or DEC for short. Lines of declination are named for their angular distance above and below the celestial equator. The lines are broken down into degrees, minutes of arc, and seconds of arc. Declination readings south of the equator carry a minus sign (-) in front of the coordinate and those north of the celestial equator are either blank (i.e., no designation) or preceded by a plus sign (+).

The celestial equivalent of longitude is called Right Ascension, or R.A. for short. Like the Earth's lines of longitude, they run from pole to pole and are evenly spaced 15 degrees apart. Although the longitude lines are separated by an angular distance, they are also a measure of time. Each line of longitude is one hour apart from the next. Since the Earth rotates once every 24 hours, there are 24 lines total. As a result, the R.A. coordinates are marked off in units of time. It begins with an arbitrary point in the constellation of Pisces designated as 0 hours, 0 minutes, 0 seconds. All other points are designated by how far (i.e., how long) they lag behind this coordinate after it passes overhead moving toward the west.

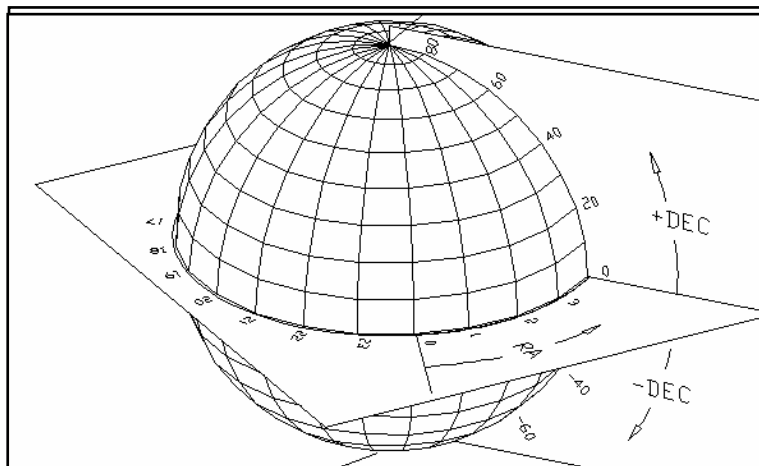

**Figure 4-1**  
The celestial sphere seen from the outside showing R.A. and DEC.

## Motion of the Stars

The daily motion of the Sun across the sky is familiar to even the most casual observer. This daily trek is not the Sun moving as early astronomers thought, but the result of the Earth's rotation. The Earth's rotation also causes the stars to do the same, scribing out a large circle as the Earth completes one rotation. The size of the circular path a star follows depends on where it is in the sky. Stars near the celestial equator form the largest circles rising in the east and setting in the west. Moving toward the north celestial pole, the point around which the stars in the northern hemisphere appear to rotate, these circles become smaller. Stars in the mid-celestial latitudes rise in the northeast and set in the northwest. Stars at high celestial latitudes are always above the horizon, and are said to be circumpolar because they never rise and never set. You will never see the stars complete one circle because the sunlight during the day washes out the starlight. However, part of this circular motion of stars in this region of the sky can be seen by setting up a camera on a tripod and opening the shutter for a couple hours. The processed film will reveal semicircles that revolve around the pole. (This description of stellar motions also applies to the southern hemisphere except all stars south of the celestial equator move around the south celestial pole.)

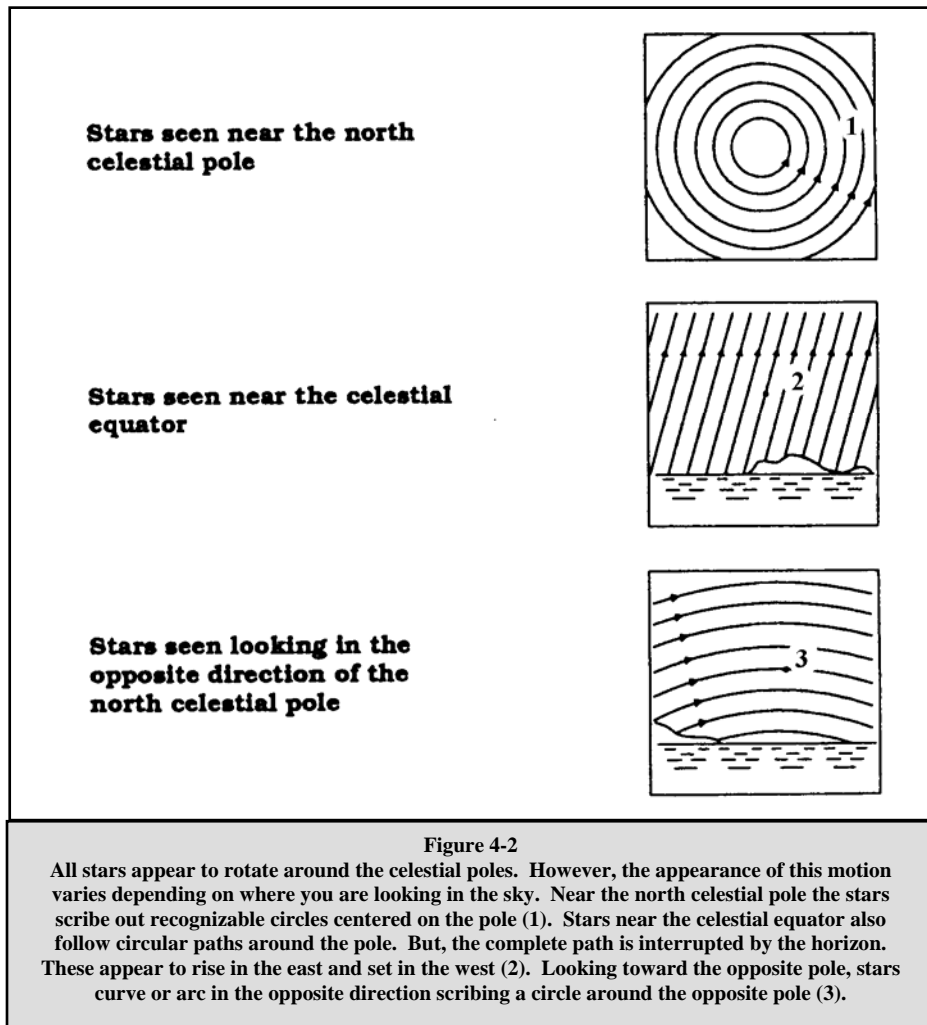



## Latitude Scale

The easiest way to polar align a telescope is with a latitude scale. Unlike other methods that require you to find the celestial pole by identifying certain stars near it, this method works off of a known constant to determine how high the polar axis should be pointed. The Omni CG-4 mount can be adjusted from about 20 to 60 degrees (see figure 5-3).

The constant, mentioned above, is a relationship between your latitude and the angular distance the celestial pole is above the northern (or southern) horizon. The angular distance from the northern horizon to the north celestial pole is always equal to your latitude. To illustrate this, imagine that you are standing on the north pole, latitude  $+90^\circ$ . The north celestial pole, which has a declination of  $+90^\circ$ , would be directly overhead (i.e.,  $90^\circ$  above the horizon). Now, let's say that you move one degree south — your latitude is now  $+89^\circ$  and the celestial pole is no longer directly overhead. It has moved one degree closer toward the northern horizon. This means the pole is now  $89^\circ$  above the



Figure 4-3

northern horizon. If you move one degree further south, the same thing happens again. You would have to travel 70 miles north or south to change your latitude by one degree. As you can see from this example, the distance from the northern horizon to the celestial pole is always equal to your latitude.

If you are observing from Los Angeles, which has a latitude of  $34^\circ$ , then the celestial pole is  $34^\circ$  above the northern horizon. All a latitude scale does then is to point the polar axis of the telescope at the right elevation above the northern (or southern) horizon. To align your telescope:

1. Make sure the polar axis of the mount is pointing due north. Use a landmark that you know faces north.
2. Level the tripod. There is a bubble level built into the mount for this purpose.

NOTE: Leveling the tripod is only necessary if using this method of polar alignment. Perfect polar alignment is still possible using other methods described later in this manual without leveling the tripod.

3. Adjust the mount in altitude until the latitude indicator points to your latitude. Moving the mount affects the angle the polar axis is pointing. For specific information on adjusting the equatorial mount, please see the section "Adjusting the Mount."

This method can be done in daylight, thus eliminating the need to fumble around in the dark. Although this method does **NOT** put you directly on the pole, it will limit the number of corrections you will make when tracking an object. It will also be accurate enough for short exposure prime focus planetary photography (a couple of seconds) and short exposure piggyback astrophotography (a couple of minutes).

## Pointing at Polaris

This method utilizes Polaris as a guidepost to the celestial pole. Since Polaris is less than a degree from the celestial pole, you can simply point the polar axis of your telescope at Polaris. Although this is by no means perfect alignment, it does get you within one degree. Unlike the previous method, this must be done in the dark when Polaris is visible.

1. Set the telescope up so that the polar axis is pointing north.
2. Loosen the DEC clutch knob and move the telescope so that the tube is parallel to the polar axis. When this is done, the declination setting circle will read  $+90^\circ$ . If the declination setting circle is not aligned, move the telescope so that the tube is parallel to the polar axis.
3. Adjust the mount in altitude and/or azimuth until Polaris is in the field of view of the finder.
4. Center Polaris in the field of the telescope using the fine adjustment controls on the mount.

**Remember, while Polar aligning, do NOT move the telescope in R.A. or DEC. You do not want to move the telescope itself, but the polar axis. The telescope is used simply to see where the polar axis is pointing.**

Like the previous method, this gets you close to the pole but not directly on it. The following methods help improve your accuracy for more serious observations and photography.

## Finding the North Celestial Pole

In each hemisphere, there is a point in the sky around which all the other stars appear to rotate. These points are called the celestial poles and are named for the hemisphere in which they reside. For example, in the northern hemisphere all stars move around the north celestial pole. When the telescope's polar axis is pointed at the celestial pole, it is parallel to the Earth's rotational axis.

Many methods of polar alignment require that you know how to find the celestial pole by identifying stars in the area. For those in the northern hemisphere, finding the celestial pole is not too difficult. Fortunately, we have a naked eye star less than a degree away. This star, Polaris, is the end star in the handle of the Little Dipper. Since the Little Dipper (technically called Ursa Minor) is not one of the brightest constellations in the sky, it may be difficult to locate from urban areas. If this is the case, use the two end stars in the bowl of the Big Dipper (the pointer stars). Draw an imaginary line through them toward the Little Dipper. They point to Polaris (see Figure 4-5). The position of the Big Dipper (Ursa Major) changes during the year and throughout the course of the night (see Figure 4-4). When the Big Dipper is low in the sky (i.e., near the horizon), it may be difficult to locate. During these times, look for Cassiopeia (see Figure 4-5). Observers in the southern hemisphere are not as fortunate as those in the northern hemisphere. The stars around the south celestial pole are not nearly as bright as those around the north. The closest star that is relatively bright is Sigma Octantis. This star is just within naked eye limit (magnitude 5.5) and lies about 59 arc minutes from the pole.

**Definition**

*The north celestial pole is the point in the northern hemisphere around which all stars appear to rotate. The counterpart in the southern hemisphere is referred to as the south celestial pole.*

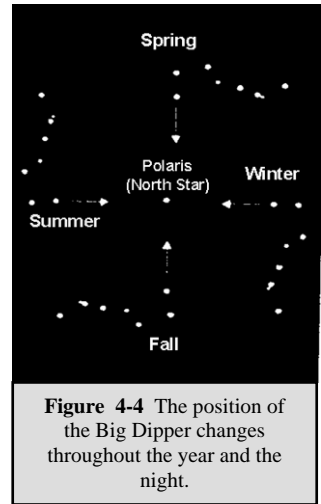

**Figure 4-4** The position of the Big Dipper changes throughout the year and the night.

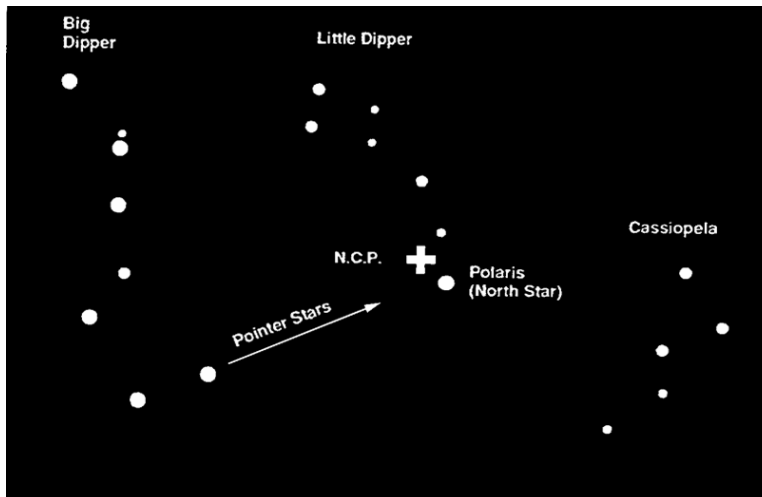

**Figure 4-5** The two stars in the front of the bowl of the Big Dipper point to Polaris which is less than one degree from the true (north) celestial pole. Cassiopeia, the “W” shaped constellation, is on the opposite side of the pole from the Big Dipper. The North Celestial Pole (N.C.P.) is marked by the “+” sign.

## ***Declination Drift Method of Polar Alignment***

This method of polar alignment allows you to get the most accurate alignment on the celestial pole and is required if you want to do long exposure deep-sky astrophotography through the telescope. The declination drift method requires that you monitor the drift of selected stars. The drift of each star tells you how far away the polar axis is pointing from the true celestial pole and in what direction. Although declination drift is simple and straight-forward, it requires a great deal of time and patience to complete when first attempted. The declination drift method should be done after any one of the previously mentioned methods has been completed.

To perform the declination drift method you need to choose two bright stars. One should be near the eastern horizon and one due south near the meridian. Both stars should be near the celestial equator (i.e.,  $0^\circ$  declination). You will monitor the drift of each star one at a time and in declination only. While monitoring a star on the meridian, any misalignment in the east-west direction is revealed. While monitoring a star near the east/west horizon, any misalignment in the north-south direction is revealed. It is helpful to have an illuminated reticle eyepiece to help you recognize any drift. For very close alignment, a Barlow lens is also recommended since it increases the magnification and reveals any drift faster. When looking due south, insert the diagonal so the eyepiece points straight up. Insert the cross hair eyepiece and align the cross hairs so that one is parallel to the declination axis and the other is parallel to the right ascension axis. Move your telescope manually in R.A. and DEC to check parallelism.

First, choose your star near where the celestial equator and the meridian meet. The star should be approximately within 1/2 an hour of the meridian and within five degrees of the celestial equator. Center the star in the field of your telescope and monitor the drift in declination.

- If the star drifts south, the polar axis is too far east.
- If the star drifts north, the polar axis is too far west.

Make the appropriate adjustments to the polar axis to eliminate any drift. Once you have eliminated all the drift, move to the star near the eastern horizon. The star should be 20 degrees above the horizon and within five degrees of the celestial equator.

- If the star drifts south, the polar axis is too low.
- If the star drifts north, the polar axis is too high.

Again, make the appropriate adjustments to the polar axis to eliminate any drift. Unfortunately, the latter adjustments interact with the prior adjustments ever so slightly. So, repeat the process again to improve the accuracy checking both axes for minimal drift. Once the drift has been eliminated, the telescope is very accurately aligned. You can now do prime focus deep-sky astrophotography for long periods.

NOTE: If the eastern horizon is blocked, you may choose a star near the western horizon, but you must reverse the polar high/low error directions. Also, if using this method in the southern hemisphere, the direction of drift is reversed for both R.A. and DEC.

## Aligning the R.A. Setting Circle

Before you can use the setting circles to find objects in the sky you need to align the R.A. setting circle. The declination setting circle is aligned during the process of polar alignment.



In order to align the R.A. setting circle, you will need to know the names of a few of the brightest stars in the sky. If you don't, they can be learned by using the Celestron Sky Maps (#93722) or consulting a current astronomy magazine.

Figure 4-6

To align the R.A. setting circle:

1. Locate a bright star near the celestial equator. The farther you are from the celestial pole the better your reading on the R.A. setting circle will be. The star you choose to align the setting circle with should be a bright one whose coordinates are known and easy to look up.
2. Center the star in the finderscope.
3. Look through the main telescope and see if the star is in the field. If not, find it and center it.
4. If you purchased an optional motor drive, start it now so that it will track the star.
5. Look up the coordinates of the star.
6. Rotate the circle until the proper coordinates line up with the R.A. indicator (the zero mark on the vernier scale). The R.A. setting circle should rotate freely. If the circle does not move freely, loosen the thumbscrew to the right of the scale.

**NOTE:** Because the R.A. setting circle does **NOT** move as the telescope moves in R.A., the setting circle must be aligned each time you want to use it to find an object. This holds true even if you are using an optional motor drive. However, you do not need to use a star each time. Instead, you can use the coordinates of the object you are currently observing.

Once the setting circles are aligned you can use them to find any objects with known coordinates. The accuracy of your setting circles is directly related to the accuracy of your polar alignment.

1. Select an object to observe. Use a seasonal star chart to make sure the object you chose is above the horizon. As you become more familiar with the night sky, this will no longer be necessary.
2. Look up the coordinates in a star atlas or reference book.
3. Hold the telescope and release the DEC clamp.
4. Move the telescope in declination until the indicator is pointing at the correct declination coordinate.
5. Lock the declination clamp to prevent the telescope from moving.
6. Hold the telescope and release the R.A. clamp.
7. Move the telescope in R.A. until the indicator points to the correct coordinate.

8. Lock the R.A. clamp to prevent the telescope from slipping in R.A. The telescope will track in R.A. as long as the motor drive is operating.
9. Look through the finderscope to see if you have located the object and center the object in the finder.
10. Look in the main optics and the object should be there. For some of the fainter objects, you may not be able to see them in the finder. When this happens, it is a good idea to have a star chart of the area so that you can “star hop” through the field to your target.

This process can be repeated for each object throughout any given night.

## Using the R.A. Vernier Scale

To increase the accuracy of the R.A. setting circle, the mount comes with a vernier scale. This device allows you to get more precise readings down to one minute of right ascension.

Before we go into the specifics on how to use the vernier, let’s take a look at the scale and learn how to read it. First, the zero (0) mark on the vernier is the R.A. indicator and will hereafter be referred to as such. It is on the extreme right end of the vernier scale with the other numbers increasing as you move toward the left.

If the R.A. indicator is right on one of the marks of the R.A. setting circle, then that is the coordinate the telescope is pointing at. The problem arises when the R.A. indicator (zero mark) is in between two of the marks on the R.A. setting circle. If this is the case you will notice that along the vernier scale, one of the marks will line up with one of the marks on the setting circle. This mark indicates the number of minutes that should be added to the R.A. reading of the indicator. Since the indicator is between two R.A. marks, add the minutes to the lower value that the R.A. indicator falls between.

For example, let’s say the R.A. indicator (zero mark on the vernier) is just left of the 5h 40m mark. This would place it between the 5h 40m mark and the 5h 50m mark. If you look down the vernier scale, you will see that the “4” is the only mark to line up with any of the marks on the R.A. setting circle (see figure 8). This means that you are 4 minutes to the left of the 5h and 40m mark or more simply at 5h and 44m.

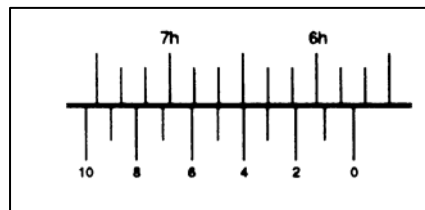

Figure 4-7 Vernier Scale

Here’s how to use the vernier:

1. Look up the coordinates of the object you want to observe. For our example we will use the Ring Nebula (M57) which is at 18h 53m right ascension.
2. Release the R.A. clamp and rotate the telescope until the R.A. indicator is between the 18h 50m mark and the 19h 00m mark on the R.A. setting circle.
3. Lock the R.A. clamp to hold the telescope in place.
  4. Move the telescope in R.A. using the slow motion control handle until the three on the vernier scale lines up with one of the marks on the R.A. setting circle. **Remember, the R.A. indicator must stay between the 18h 50m mark and the 19h 00m mark on the R.A. setting circle!**
5. Look through the telescope and the Ring Nebula should be within the field of view if you are using a low power eyepiece (assuming you have already set the DEC).

# **Celestial Observing**

With your telescope set up, you are ready to use it for observing. This section covers visual observing hints for both solar system and deep sky objects as well as general observing conditions which will affect your ability to observe.

## **Observing the Moon**

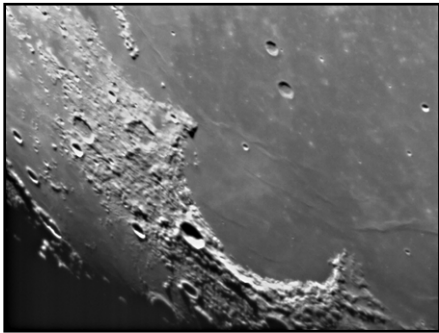

Often, it is tempting to look at the Moon when it is full. At this time, the face we see is fully illuminated and its light can be overpowering. In addition, little or no contrast can be seen during this phase.

One of the best times to observe the Moon is during its partial phases (around the time of first or third quarter). Long shadows reveal a great amount of detail on the lunar surface. At low power you will be able to see most of the lunar disk at one time. For the Schmidt-Cassegrain telescope, the optional Reducer/Corrector lens allows for breath-taking views of the entire lunar disk when used with low power eyepieces. Change to optional eyepieces for higher power (magnification) to focus in on a smaller area.

## **Lunar Observing Hints**

To increase contrast and bring out detail on the lunar surface, use optional filters. A yellow filter works well at improving contrast while a neutral density or polarizing filter will reduce overall surface brightness and glare.

## **Observing the Planets**

Other fascinating targets include the five naked eye planets. You can see Venus go through its lunar-like phases. Mars can reveal a host of surface detail and one, if not both, of its polar caps. You will be able to see the cloud belts of Jupiter and the great Red Spot (if it is visible at the time you are observing). In addition, you will also be able to see the moons of Jupiter as they orbit the giant planet. Saturn, with its beautiful rings, is easily visible at moderate power.

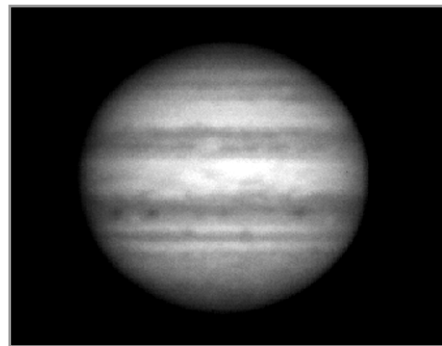

### **Planetary Observing Hints**

- Remember that atmospheric conditions are usually the limiting factor on how much planetary detail will be visible. So, avoid observing the planets when they are low on the horizon or when they are directly over a source of radiating heat, such as a rooftop or chimney. See the "Seeing Conditions" section later in this section.
- To increase contrast and bring out detail on the planetary surface, try using Celestron eyepiece filters.

## ***Observing the Sun***

Although overlooked by many amateur astronomers, solar observation is both rewarding and fun. However, because the Sun is so bright, special precautions must be taken when observing our star so as not to damage your eyes or your telescope.

Never project an image of the Sun through the telescope. Because of the folded optical design, tremendous heat build-up will result inside the optical tube. This can damage the telescope and/or any accessories attached to the telescope.

For safe solar viewing, use a solar filter that reduces the intensity of the Sun's light, making it safe to view. With a filter you can see sunspots as they move across the solar disk and faculae, which are bright patches seen near the Sun's edge.

## ***Solar Observing Hints***

- The best time to observe the Sun is in the early morning or late afternoon when the air is cooler.
- To center the Sun without looking into the eyepiece, watch the shadow of the telescope tube until it forms a circular shadow.
- To ensure accurate tracking, be sure to select the solar tracking rate.

## ***Observing Deep Sky Objects***

Deep-sky objects are simply those objects outside the boundaries of our solar system. They include star clusters, planetary nebulae, diffuse nebulae, double stars and other galaxies outside our own Milky Way. Most deep-sky objects have a large angular size. Therefore, low-to-moderate power is all you need to see them. Visually, they are too faint to reveal any of the color seen in long exposure photographs. Instead, they appear black and white. And, because of their low surface brightness, they should be observed from a dark-sky location. Light pollution around large urban areas washes out most nebulae making them difficult, if not impossible, to observe. Light Pollution Reduction filters help reduce the background sky brightness, thus increasing contrast.

## ***Seeing Conditions***

Viewing conditions affect what you can see through your telescope during an observing session. Conditions include transparency, sky illumination, and seeing. Understanding viewing conditions and the effect they have on observing will help you get the most out of your telescope.

## ***Transparency***

Transparency is the clarity of the atmosphere which is affected by clouds, moisture, and other airborne particles. Thick cumulus clouds are completely opaque while cirrus can be thin, allowing the light from the brightest stars through. Hazy skies absorb more light than clear skies making fainter objects harder to see and reducing contrast on brighter objects. Aerosols ejected into the upper atmosphere from volcanic eruptions also affect transparency. Ideal conditions are when the night sky is inky black.

## ***Sky Illumination***

General sky brightening caused by the Moon, aurorae, natural airglow, and light pollution greatly affect transparency. While not a problem for the brighter stars and planets, bright skies reduce the contrast of extended nebulae making them difficult, if not impossible, to see. To maximize your observing, limit deep sky viewing to moonless nights far from the light polluted skies found around major urban areas. LPR filters enhance deep sky viewing from light polluted areas by blocking unwanted light while transmitting light from certain deep sky objects. You can, on the other hand, observe planets and stars from light polluted areas or when the Moon is out.

## Seeing

Seeing conditions refers to the stability of the atmosphere and directly affects the amount of fine detail seen in extended objects. The air in our atmosphere acts as a lens which bends and distorts incoming light rays. The amount of bending depends on air density. Varying temperature layers have different densities and, therefore, bend light differently. Light rays from the same object arrive slightly displaced creating an imperfect or smeared image. These atmospheric disturbances vary from time-to-time and place-to-place. The size of the air parcels compared to your aperture determines the "seeing" quality. Under good seeing conditions, fine detail is visible on the brighter planets like Jupiter and Mars, and stars are pinpoint images. Under poor seeing conditions, images are blurred and stars appear as blobs.

The conditions described here apply to both visual and photographic observations.

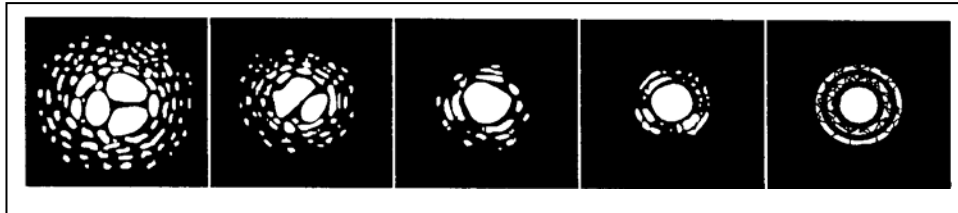

**Figure 5-1**

**Seeing conditions directly affect image quality. These drawings represent a point source (i.e., star) under bad seeing conditions (left) to excellent conditions (right). Most often, seeing conditions produce images that lie some where between these two extremes.**

## ***Using the Lens Cap Aperture Stop with Refractor Telescopes***

As mentioned earlier, all refractive optics will exhibit some amount of chromatic aberration due to the prism effect of lenses. Chromatic aberration will become more pronounced the farther the incoming light rays are off-axis (i.e. passing through the edge of the objective lens) and virtually unnoticeable on-axis (passing through the center of the objective lens). This type of aberration is only evident when observing very bright sources of light, such as bright planets and very luminous stars (like Sirius). There are several techniques that the observer can employ to suppress visible signs of chromatic aberration, these include; reducing the aperture and using filters.

The objective lens cap covering the objective lens of the telescope has a built-in aperture stop in the center. By leaving the lens cap on the telescope with the aperture stop removed, you will allow all the incoming light to pass closer to the center of the optical axis. Since, most planets are extremely bright objects (visible to the unaided eye) any loss of light from reducing the aperture will be unnoticeable.

The lens cap should always be completely removed when observing deep-sky objects such as galaxies and nebulae, where aperture (light gathering power) is essential and chromatic aberration is not an issue.

Another useful technique for reducing aberrations and improving planetary detail is the use of colored eyepiece filters. Filters are commonly used to bring out particular planetary detail, such as the polar caps on Mars or the bands and zones around Jupiter. The use of Celestron's Refractor Filter (# 94121) reduces the effect of chromatic aberration as well as improves contrast and resolution.



The logo for Celestron Astrophotography. It features the word "CELESTRON" in a bold, sans-serif font with a stylized "C" logo to its left. Below it, the word "Astrophotography" is written in a larger, bold, serif font with a slight shadow effect. The entire logo is enclosed in a thin black rectangular border.

After looking at the night sky for a while you may want to try photographing it. Several forms of photography are possible with your telescope, including terrestrial and celestial photography. Both of these are discussed in moderate detail with enough information to get you started. Topics include the accessories required and some simple techniques. More information is available in various books on the subject matter.

Below is described the traditional photographic methods with traditional equipment. During the last several years, digital cameras have become very popular and you can use this latest technology to take images through telescopes and it is relatively simple. In addition, CCD cameras (specifically made for astrophotography as well as Lunar and Planetary photography) have become more economical for hobbyists to procure and have opened new avenues for fantastic images.

In addition to the specific accessories required for each type of celestial photography, there is the need for a camera - but not just any camera. The camera does not have to have many of the features offered on today's state-of-the-art equipment. For example, you don't need auto focus capability or mirror lock up. Here are the mandatory features a camera needs for celestial photography. First, a "B" setting which allows for time exposures and this excludes point and shoot cameras and limits the selection to SLR cameras, the most common type of 35mm camera on the market today.

Second, the "B" or manual setting should NOT run off the battery. Many new electronic cameras use the battery to keep the shutter open during time exposures. Once the batteries are drained, usually after a few minutes, the shutter closes, whether you were finished with the exposure or not. Look for a camera that has a manual shutter when operating in the time exposure mode. Canon, Olympus, Nikon, Pentax, Minolta, and others have made such camera bodies.

The camera must have interchangeable lenses so you can attach it to the telescope and so you can use a variety of lenses for piggyback photography. If you can't find a new camera, you can purchase a used camera body that is not 100-percent functional. The light meter, for example, does not have to be operational since you will be determining the exposure length manually.

You also need a cable release with a locking function to hold the shutter open while you do other things. Mechanical and air release models are available.

## ***Piggyback Photography***

The easiest way to enter the realm of deep-sky, long exposure astrophotography is via the piggyback method. Piggyback photography is done with a camera and its normal lens riding on top of the telescope. Through piggyback photography you can capture entire constellations and record large scale nebulae that are too big for prime focus photography. Because you are photographing with a low power lens and guiding with a high power telescope, the margin for error is very large. Small mistakes made while guiding the telescope will not show up on film. To attach the camera to the refractor or Newtonian telescope, use the piggyback adapter screw located on the top of the tube mounting ring. For the Schmidt-Cassegrain telescope there is an optional Piggyback Camera Mount available. The cameras have a threaded hole at the bottom of the camera where the piggyback screw threads into.

As with any form of deep-sky photography, it should be done from a dark sky observing site. Light pollution around major urban areas washes out the faint light of deep-sky objects. You can still practice from less ideal skies.

1. Polar align the telescope (using one of the methods described earlier) and start the optional motor drive.
2. Load your camera with slide film, ISO 100 or faster, or print film, ISO 400 or faster!
  - 2a. When using digital cameras, experiment with various settings and read the camera instructions as each is somewhat different than SLR cameras.
3. Set the  $f$ /ratio of your camera lens so that it is a half stop to one full stop down from completely open.

4. Set the shutter speed to the “B” setting and focus the lens to the infinity setting.
5. Locate the area of the sky that you want to photograph and move the telescope so that it points in that direction.
6. Find a suitable guide star in the telescope eyepiece field of view. This is relatively easy since you can search a wide area without affecting the area covered by your camera lens. If you do not have an illuminated cross hair eyepiece for guiding, simply defocus your guide star until it fills most of the field of view. This makes it easy to detect any drift.
7. Release the shutter using a cable release.
8. Monitor your guide star for the duration of the exposure making the necessary corrections needed to keep the star centered.

### ***Short Exposure Prime Focus Photography for Refractors & Newtonians***

Short exposure prime focus photography is the best way to begin recording celestial objects. It is done with the SLR camera attached to the telescope without an eyepiece or camera lens in place. To attach your SLR camera, you need the T-adapter and a T-Ring for your specific camera (i.e., Minolta, Nikon, Pentax, etc.). The focuser for the refractors and Newtonian have a built-in T-adapter and they are ready to accept a 35mm camera body. The T-Ring replaces the 35mm SLR camera’s normal lens. Prime focus photography allows you to capture the entire solar disk (if using the proper filter) as well as the entire lunar disk. To attach your camera to your telescope: **See note about digital cameras below.**

1. Remove the eyepiece from the 1 1/4" eyepiece holder.
2. Unthread the 1 1/4" eyepiece holder from the focuser assembly. This will expose the male thread of the built-in T-adapter.
3. Thread the T-ring onto the exposed T-adapter threads.
4. Mount your camera body onto the T-Ring the same as you would any other lens.

### ***Short Exposure Prime Focus Photography for Schmidt-Cassegrains***

Use a T-Adapter ( # 93633-A) which threads on to the back of the telescope. The T-Ring threads onto the T-Adapter and then mount your camera body onto the T-Ring like you would any other lens.

### **Using Digital Cameras**

To attach a digital camera to your telescope you will need the Universal Digital Camera Adapter ( # 93626). The adapter allows the camera to be mounted rigidly. You will follow your camera instructions for capturing images as the information below relates to 35mm SLR cameras. With your camera attached to the telescope, you are ready for prime focus photography. Start with an easy object like the Moon. Here’s how to do it:

1. Load your camera with film that has a moderate-to-fast speed (i.e., ISO rating). Faster films are more desirable when the Moon is a crescent. When the Moon is near full, and at its brightest, slower films are more desirable. Here are some film recommendations:
  - T-Max 100
  - T-Max 400

- Any 100 to 400 ISO color slide film
  - Fuji Super HG 400
2. Center the Moon in the field of your telescope.
  3. Focus the telescope by turning the focus knob until the image is sharp.
  4. Set the shutter speed to the appropriate setting (see table 7-1).
  5. Trip the shutter using a cable release.
  6. Advance the film and repeat the process.

Lunar Phase	ISO 50	ISO 100	ISO 200	ISO 400
Crescent	1/2	1/4	1/8	1/15
Quarter	1/15	1/30	1/60	1/125
Full	1/30	1/60	1/125	1/250

**Table 6-1**  
Above is a listing of recommended exposure times when photographing the Moon at the prime focus of your telescope.

The exposure times listed in table 7-1 should be used as a starting point. Always make exposures that are longer and shorter than the recommended time. Also, take a few photos at each shutter speed. This will ensure that you will get a good photo.

- If using black and white film, try a yellow filter to reduce the light intensity and to increase contrast.
- Keep accurate records of your exposures. This information is useful if you want to repeat your results or if you want to submit some of your photos to various astronomy magazines for possible publication!
- This technique is also used for photographing the Sun with the proper solar filter.

## ***Eyepiece Projection for a Schmidt-Cassegrain***

This form of celestial photography is designed for objects with small angular sizes, primarily the Moon and planets. Planets, although physically quite large, appear small in angular size because of their great distances. Moderate to high magnification is, therefore, required to make the image large enough to see any detail. Unfortunately, the camera/telescope combination alone does not provide enough magnification to produce a usable image size on film. In order to get the image large enough, you must attach your camera to the telescope with the eyepiece in place. To do so, you need two additional accessories; a deluxe tele-extender (#93643), which attaches to the visual back, and a T-ring for your particular camera make (i.e., Minolta, Nikon, Pentax, etc.).

Because of the high magnifications during eyepiece projection, the field of view is quite small which makes it difficult to find and center objects. To make the job a little easier, align the finder as accurately as possible. This allows you to get the object in the telescope's field based on the finder's view alone.

Another problem introduced by the high magnification is vibration. Simply tripping the shutter — even with a cable release — produces enough vibration to smear the image. To get around this, use the camera's self-timer if the exposure time is less than one second — a common occurrence when photographing the Moon. For exposures over one second, use the "hat trick." This technique incorporates a hand-held black card placed over the aperture of the telescope to act as a shutter. The card prevents light from entering the telescope while the shutter is released. Once the shutter has been released and the vibration has diminished (a few seconds), move the black card out of the way to expose the film. After the exposure is complete, place the card over the front of the telescope and close the shutter. Advance the film and you're ready for your next shot. Keep in mind that the card should be held a few inches in front of the telescope, and not touching it. It is easier if you use two people for this process; one to release the camera shutter and one to hold the card. Here's the process for making the exposure.

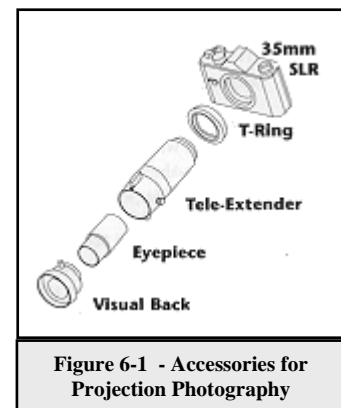

**Figure 6-1 - Accessories for Projection Photography**

1. Find and center the desired target in the viewfinder of your camera.
2. Turn the focus knob until the image is as sharp as possible.
3. Place the black card over the front of the telescope.
4. Release the shutter using a cable release.
5. Wait for the vibration caused by releasing the shutter to diminish. Also, wait for a moment of good seeing.
6. Remove the black card from in front of the telescope for the duration of the exposure (see accompanying table).
7. Replace the black card over the front of the telescope.
8. Close the camera's shutter.

Advance the film and you are ready for your next exposure. Don't forget to take photos of varying duration and keep accurate records of what you have done. Record the date, telescope, exposure duration, eyepiece, f/ratio, film, and some comments on the seeing conditions.

The following table lists exposures for eyepiece projection with a 10mm eyepiece. All exposure times are listed in seconds or fractions of a second.

Planet	ISO 50	ISO 100	ISO 200	ISO 400
Moon	4	2	1	1/2
Mercury	16	8	4	2
Venus	1/2	1/4	1/8	1/15
Mars	16	8	4	2
Jupiter	8	4	2	1
Saturn	16	8	4	2

**Table 6-2  
Recommended exposure time for photographing planets.**

The exposure times listed here should be used as a starting point. Always make exposures that are longer and shorter than the recommended time. Also, take a few photos at each shutter speed. This will ensure that you get a good photo. It is not uncommon to go through an entire roll of 36 exposures and have only one good shot.

**NOTE:** Don't expect to record more detail than you can see visually in the eyepiece at the time you are photographing.

Once you have mastered the technique, experiment with different films, different focal length eyepieces, and even different filters.

## ***Long Exposure Prime Focus Photography***

This is the last form of celestial photography to be attempted after others have been mastered. It is intended primarily for deep sky objects, that is objects outside our solar system which includes star clusters, nebulae, and galaxies. While it may seem that high magnification is required for these objects, just the opposite is true. Most of these objects cover large angular areas and fit nicely into the prime focus field of your telescope. The brightness of these objects, however, requires long exposure times and, as a result, are rather difficult.

There are several techniques for this type of photography, and the one chosen will determine the standard accessories needed. The best method for long exposure deep sky astrophotography is with an off-axis guider when you are using a Schmidt-Cassegrain. This device allows you to photograph and guide through the telescope simultaneously. Celestron offers a very special and advanced off-axis guider, called the Radial Guider (# 94176). In addition, you will need a T-Ring to attach your camera to the Radial Guider. With refractor and Newtonian telescopes you skip the comments about the Radial Guider but all else applies.

Other equipment needs include a guiding eyepiece. Unlike other forms of astrophotography which allows for fairly loose guiding, prime focus requires meticulous guiding for long periods. To accomplish this you need a guiding ocular

with an illuminated reticle to monitor your guide star. For this purpose, Celestron offers the Micro Guide Eyepiece (# 94171) Here is a brief summary of the technique.

**Note: Digital Cameras – follow the camera instructions on focusing and shutter data.**

1. Polar align the telescope. For more information on polar aligning, see the Polar Alignment section earlier in the manual.
2. Remove all visual accessories.
3. Thread the Radial Guider onto your telescope.
4. Thread the T-Ring onto the Radial Guider.
5. Mount your camera body onto the T-Ring the same as you would any other lens.
6. Set the shutter speed to the "B" setting.
7. Focus the telescope on a star.
8. Center your subject in the field of your camera.
9. Find a suitable guide star in the telescope field. This can be the most time consuming process.
10. Open the shutter using a cable release.
11. Monitor your guide star for the duration of the exposure using the buttons on the hand controller to make the needed corrections.
12. Close the camera's shutter.

When getting started, use fast films to record as much detail in the shortest possible time. Here are proven recommendations:

- Ektar 1000 (color print)
- Konica 3200 (color print)
- Fujichrome 1600D (color slide)
- 3M 1000 (color slide)
- Scotchchrome 400
- T-Max 3200 (black and white print)
- T-Max 400 (black and white print)

As you perfect your technique, try specialized films, that is films that are designed or specially treated for celestial photography. Here are some popular choices:

- Ektar 125 (color print)
- Fujichrome 100D (color slide)
- Tech Pan, gas hypered (black and white print)
- T-Max 400 (black and white print)

There is no exposure determination table to help you get started. The best way to determine exposure length is look at previously published photos to see what film/exposure combinations were used. Or take unguided sample photos of various parts of the sky while the drive is running. Always take exposures of various lengths to determine the best exposure

## ***Planetary and Lunar Photography with Special Imagers***

During the last few years a new technology has evolved which makes taking superb images of the planets and moon relatively easy and the results are truly amazing. Celestron offers the NexImage (# 93712) which is a special camera and included is software for image processing. You can capture planetary images your first night out which rivals what professionals were doing with large telescopes just a few short years ago.

## ***CCD Imaging for Deep Sky Objects***

Special cameras have been developed for taking images of deep sky images. These have evolved over the last several years to become much more economical and amateurs can take fantastic images. Several books have been written on how to get the best images possible. The technology continues to evolve with better and easier to use products on the market.

## ***Terrestrial Photography***

Your telescope makes an excellent telephoto lens for terrestrial (land) photography. Your telescope is in essence a long focal length telephoto lens. 35mm SLR cameras are mounted directly to the telescope (using the built-in T-Adapter on the refractors and Newtonian or using the # 93633-A T-Adapter for the Schmidt-Cassegrain). For using a digital camera you will need the Universal Digital Camera Adapter (# 93626).

You can take images of various scenic views, wildlife, nature, and just about anything. You will have to experiment with focusing, speeds, etc. to get the best image desired.

## ***Metering***

The Omni Series telescopes have fixed apertures and, as a result, fixed f/ratios. To properly expose your subjects photographically, you need to set your shutter speed accordingly. Most 35mm SLR cameras offer through-the-lens metering which lets you know if your picture is under or overexposed. Adjustments for proper exposures are made by changing the shutter speed. Consult your camera manual for specific information on metering and changing shutter speeds.

## ***Reducing Vibration***

Releasing the shutter manually can cause vibrations, producing blurred photos. To reduce vibration when tripping the shutter, use a cable release. A cable release keeps your hands clear of the camera and lens, thus eliminating the possibility of introducing vibration. Mechanical shutter releases can be used, though air-type releases are best. Blurry pictures can also result from shutter speeds that are too slow. To prevent this, use films that produce shutter speeds greater than 1/250 of a second when hand-holding the lens. If the lens is mounted on a tripod, the exposure length is virtually unlimited.

Another way to reduce vibration is with the Vibration Suppression Pads (#93503). These pads rest between the ground and tripod feet. They reduce the vibration amplitude and vibration time.



# Telescope Maintenance

While your telescope requires little maintenance, there are a few things to remember that will ensure your telescope performs at its best. Each optical design type has special collimation instructions described below.

## Care and Cleaning of the Optics

Occasionally, dust and/or moisture may build up on the objective lens, the corrector plate, or primary mirror depending on which type of telescope you have. Special care should be taken when cleaning any instrument so as not to damage the optics.

If dust has built up on the optics, remove it with a brush (made of camel's hair) or a can of pressurized air. Spray at an angle to the glass surface for approximately two to four seconds. Then, use an optical cleaning solution and white tissue paper to remove any remaining debris. Apply the solution to the tissue and then apply the tissue paper to the optics. Low pressure strokes should go from the center of the lens to the outer portion. **Do NOT rub in circles!**

You can use a commercially made lens cleaner or mix your own. A good cleaning solution is isopropyl alcohol mixed with distilled water. The solution should be 60% isopropyl alcohol and 40% distilled water. Or, liquid dish soap diluted with water (a couple of drops per one quart of water) can be used.

Occasionally, you may experience dew build-up on the optics of your telescope during an observing session. If you want to continue observing, the dew must be removed, either with a hair dryer (on low setting) or by pointing the telescope at the ground until the dew has evaporated.

If moisture condenses on the inside of the optics, remove the accessories from the telescope. Place the telescope in a dust-free environment and point it down. This will remove the moisture from the telescope tube.

To minimize the need to clean your telescope, replace all lens covers once you have finished using it. Since the cells are NOT sealed, the covers should be placed over the openings when not in use. This will prevent contaminants from entering the optical tube.

Internal adjustments and cleaning should be done only by the Celestron repair department. If your telescope is in need of internal cleaning, please call the factory for a return authorization number and price quote.

## Collimation of Refractors

Be sure to completely read carefully before attempting collimation. Collimation is the process of aligning the optical axis of each optical element with each other and with the mechanical axis of the telescope tube. For a refractor telescope design this means aligning the optical axis of the objective lens with the optical axis of the eyepiece on the other end of the tube. Your Omni refractor was properly aligned at the factory, however rough handling while traveling may eventually alter the alignment of the lens. Your Celestron refractor telescope comes with a fully adjustable objective lens housing to ensure proper alignment of the optical axis.

To determine whether or not re-collimation is necessary, the telescope should be set up outside at night. It should be a still night and one in which you have let the telescope sit outside for 15 to 30 minutes before attempting collimation. You should also wait for a night with good seeing conditions and avoid looking over anything that produces heat waves (i.e., roof tops, car hoods, etc.).

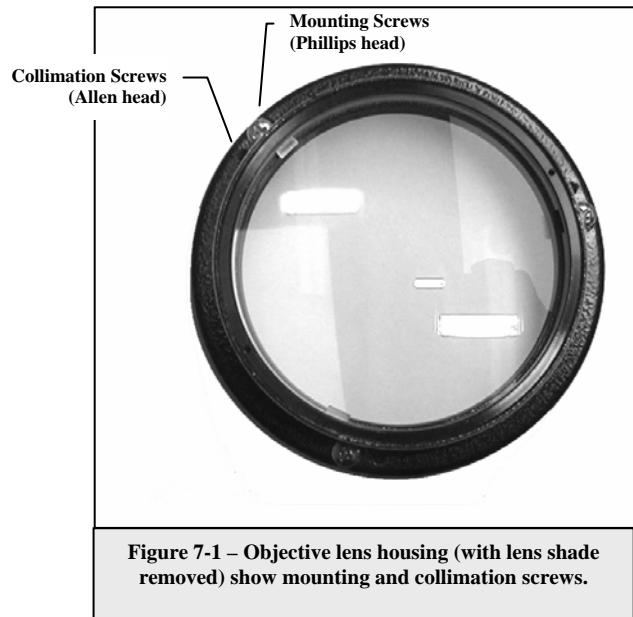

Figure 7-1 – Objective lens housing (with lens shade removed) show mounting and collimation screws.

Pick a bright star and center it in the field of the telescope. Study the image of the star while racking it in and out of focus using an eyepiece that yields 30 to 60 power for every inch of aperture. If an unsymmetrical focus pattern is present, then collimation is necessary. (If the telescope is properly collimated, the out of focus star image will appear as a concentric ring pattern similar to that shown in Figure 7-2).

To collimate, the telescope should be on either a motor driven (i.e., tracking) equatorial mount that is approximately polar aligned or pointed at a stationary star without the motor drive running. Polaris, the North Star, is the perfect collimation star for northern hemisphere observers since it appears motionless against the background sky long enough to perform the collimation procedure. Polaris is the last star in the handle of the Little Dipper (Ursa Minor) and its distance above the northern horizon is always equal to your latitude angle.

Prior to collimating, locate the three (3) mounting screws on the objective lens housing on the front of the tube. (These screws attach the objective lens housing to the main tube and should not be removed). It may be necessary to remove the lens shade from the front of the tube to allow easy access to the collimation screws. Next to each mounting screw is a shorter Allen screw collimation screw) that pushes against the optical tube to pivot the objective lens housing (see Figure 7-1). In order to make an adjustment, the mounting screw is loosened while the Allen screw is turned in or out. Then, the mounting screw is tightened. Only one of the three (3) sets is adjusted at a time. Normally motions on the order of 1/8 turn will make a difference, with only about 1/2 to 3/4 turn being the maximum required. **Do NOT remove or back out the holder screws more than one (1) to two (2) turns!**

With Polaris or another bright star centered in the field of view, focus with your highest power eyepiece (i.e., one with the shortest focal length). This includes eyepieces in the 4mm to 6mm range. The star should be well centered in the field of view of the eyepiece. It may be helpful for two people working together, while one views and instructs the other which screws are correctly turned and by how much. Start by loosening the Phillips head (mounting) screws about 1 turn and advancing the Allen screw to see if the motion is correct. If not, undo what you did and try another set of screws.

After making the first of each adjustment, it is necessary to re-aim the telescope tube to center the star again in the field of view. It can then be judged for symmetry by going just inside and outside of exact focus and noting the star's pattern. Improvement should be seen if the proper adjustments are made. Since three (3) sets of screws are present, it may be necessary to move at least two (2) sets of screws to achieve the necessary lens movement. **Do NOT over tighten the outer mounting screws!**

Once in collimation, your telescope should not need additional collimation unless the telescope has been bumped or jarred severely. In fact, most observers will find the telescope's collimation right out of the box to be satisfactory. Exact collimation is only necessary for discriminating observers that require optimal imagery.

**Refractor Collimating Eyepiece-** Your refractor includes a collimating eyepiece that can help you to roughly check the alignment of your telescope in the daytime. The collimating eyepiece has a pin hole site that helps you determine if the optics are properly aligned with the tube. With the focuser racked in all the way and the diagonal removed, place the collimating eyepiece inside the focuser tube. If the telescope is properly collimated, you should be able to see the entire edge of the objective lens when looking through the pin hole. If the objective lens appears oval, then it may be necessary to collimate the telescope as described above.

## Collimation of a Schmidt-Cassegrain

The optical performance of your telescope is directly related to its collimation, that is the alignment of its optical system. Your telescope was collimated at the factory after it was completely assembled. However, if the telescope is dropped or jarred severely during transport, it may have to be collimated. The only optical element that may need to be adjusted, or is possible, is the tilt of the secondary mirror.

To check the collimation of your telescope you will need a light source. A bright star near the zenith is ideal since there is a minimal amount of atmospheric distortion. Make sure that tracking (with an optional motor drive) is on so that you won't have to manually track the star. Or, if you do not want to power up your telescope, you can use Polaris. Its position relative to the celestial pole means that it moves very little thus eliminating the need to manually track it.

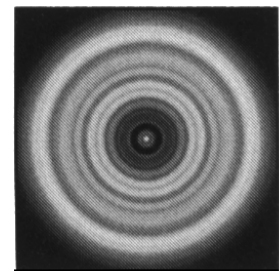

**Figure 7-2**  
A collimated telescope should appear as a symmetrical ring pattern similar to the diffraction disk seen here.

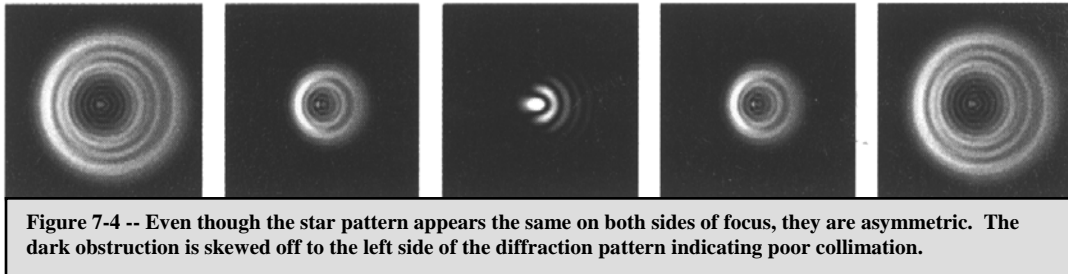

**Figure 7-3**  
The three collimation screws are located on the front of the secondary mirror housing.



Before you begin the collimation process, be sure that your telescope is in thermal equilibrium with the surroundings. Allow 45 minutes for the telescope to reach equilibrium if you move between large temperature extremes.

To verify collimation, view a star near the zenith. Use a medium to high power ocular — 12mm to 6mm focal length. It is important to center a star in the center of the field to judge collimation. Slowly cross in and out of focus and judge the symmetry of the star. If you see a systematic skewing of the star to one side, then re-collimation is needed.



To accomplish this, you need to tighten the secondary collimation screw(s) that move the star across the field toward the direction of the skewed light. These screws are located in the secondary mirror holder (see figure 7-3). Make only small 1/6 to 1/8 adjustments to the collimation screws and re-center the star by moving the scope before making any improvements or before making further adjustments.

To make collimation a simple procedure, follow these easy steps:

1. While looking through a medium to high power eyepiece, de-focus a bright star until a ring pattern with a dark shadow appears (see figure 7-4). Center the de-focused star and notice in which direction the central shadow is skewed.
2. Place your finger along the edge of the front cell of the telescope (be careful not to touch the corrector plate), pointing towards the collimation screws. The shadow of your finger should be visible when looking into the eyepiece. Rotate your finger around the tube edge until its shadow is seen closest to the narrowest portion of the rings (i.e. the same direction in which the central shadow is skewed).
3. Locate the collimation screw closest to where your finger is positioned. This will be the collimation screw you will need to adjust first. (If your finger is positioned exactly between two of the collimation screws, then you will need to adjust the screw opposite where your finger is located).
4. Use the hand control buttons to move the de-focused star image to the edge of the field of view, in the same direction that the central obstruction of the star image is skewed.
5. While looking through the eyepiece, use an Allen wrench to turn the collimation screw you located in step 2 and 3. Usually a tenth of a turn is enough to notice a change in collimation. If the star image moves out of the field of view in the direction that the central shadow is skewed, then you are turning the collimation screw the wrong way. Turn the screw in the opposite direction, so that the star image is moving towards the center of the field of view.
6. If while turning you notice that the screws get very loose, then simply tighten the other two screws by the same amount. Conversely, if the collimation screw gets too tight, then loosen the other two screws by the same amount.
7. Once the star image is in the center of the field of view, check to see if the rings are concentric. If the central obstruction is still skewed in the same direction, then continue turning the screw(s) in the same direction. If you find that the ring pattern is skewed in a different direction, then simply repeat steps 2 through 6 as described above for the new direction.

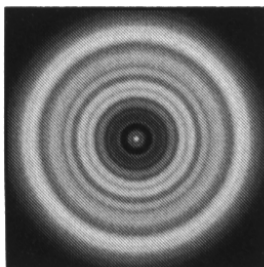

**Figure 7-5**  
A collimated telescope should appear symmetrical with the central obstruction centered in the star's diffraction pattern.

Perfect collimation will yield a star image very symmetrical just inside and outside of focus. In addition, perfect collimation delivers the optimal optical performance specifications that your telescope is built to achieve.

If seeing (i.e., air steadiness) is turbulent, collimation is difficult to judge. Wait until a better night if it is turbulent or aim to a steadier part of the sky. A steadier part of the sky is judged by steady versus twinkling stars.

## **Collimation of a Newtonian**

The optical performance of most Newtonian reflecting telescopes can be optimized by re-collimating (aligning) the telescope's optics, as needed. To collimate the telescope simply means to bring its optical elements into balance. Poor collimation will result in optical aberrations and distortions.

Before collimating your telescope, take time to familiarize yourself with all its components. The primary mirror is the large mirror at the back end of the telescope tube. This mirror is adjusted by loosening and tightening the three screws, placed 120 degrees apart, at the end of the telescope tube. The secondary mirror (the small, elliptical mirror under the focuser, in the front of the tube) also has three adjustment screws. To determine if your telescope needs collimation first point your telescope toward a bright wall or blue sky outside.



Never look directly at the sun with the naked eye or with a telescope (unless you have the proper solar filter). Permanent and irreversible eye damage may result.

### **Aligning the Secondary Mirror**

The following describes the procedure for daytime collimation of your telescope using the optional Newtonian Collimation Tool (#94183) offered by Celestron. To collimate the telescope without the Collimation Tool, read the following section on night time star collimation. For very precise collimation, the optional Collimation Eyepiece 1 1/4" (# 94182) is offered.

If you have an eyepiece in the focuser, remove it. Rack the focuser tube in completely, using the focusing knobs, until its silver tube is no longer visible. You will be looking through the focuser at a reflection of the secondary mirror, projected from the primary mirror. During this step, ignore the silhouetted reflection from the primary mirror. Insert the collimating cap into the focuser and look through it. With the focus pulled in all the way, you should be able to see the entire primary mirror reflected in the secondary mirror. If the primary mirror is not centered in the secondary mirror, adjust the secondary mirror screws by alternately tightening and loosening them

until the periphery of the primary mirror is centered in your view. **DO NOT** loosen or tighten the center screw in the secondary mirror support, because it maintains proper mirror position.

### **Aligning the Primary Mirror**

Now adjust the primary mirror screws to re-center the reflection of the small secondary mirror, so it's silhouetted against the view of the primary. As you look into the focuser, silhouettes of the mirrors should look concentric. Repeat steps one and two until you have achieved this.

Remove the collimating cap and look into the focuser, where you should see the reflection of your eye in the secondary mirror.

# Newtonian collimation views as seen through the focuser using the collimation cap

Secondary mirror needs adjustment.

Primary mirror needs adjustment.

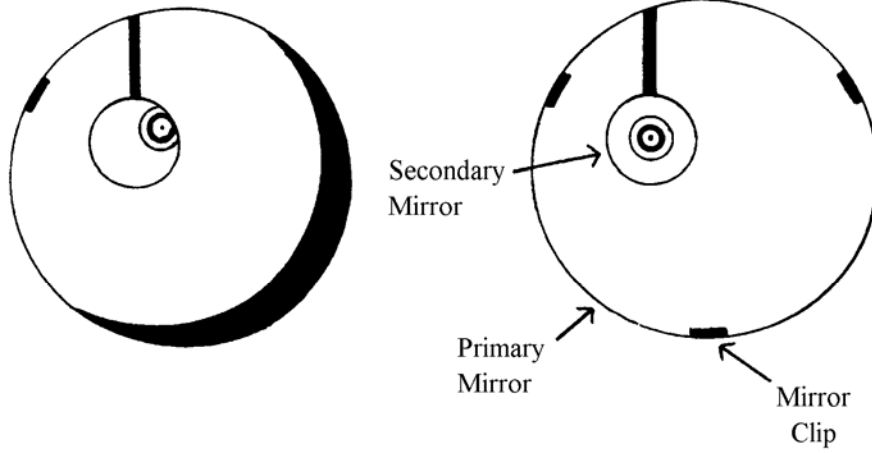

Both mirrors aligned with the collimating cap in the focuser.

Both mirrors aligned with your eye looking into the focuser.

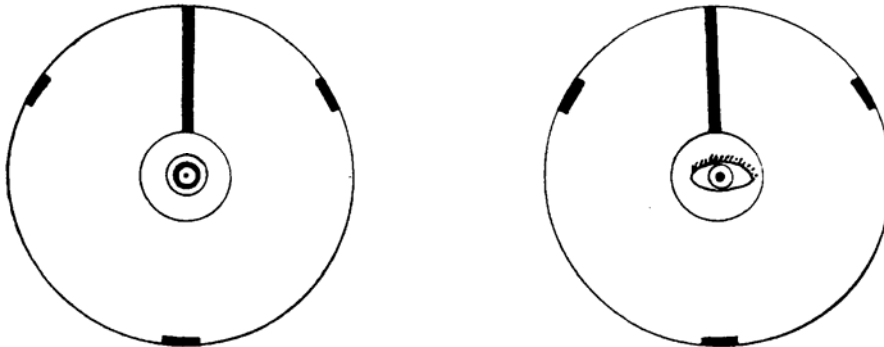

## Night Time Star Collimating

After successfully completing daytime collimation, night time star collimation can be done by closely adjusting the primary mirror while the telescope tube is on its mount and pointing at a bright star. The telescope should be set up at night and a star's image should be studied at medium to high power (30-60 power per inch of aperture). If a non-symmetrical focus pattern is present, then it may be possible to correct this by re-collimating only the primary mirror.

### Procedure

**(Please read this section completely before beginning)**

To star collimate in the Northern Hemisphere, point at a stationary star like the North Star (Polaris). It can be found in the north sky, at a distance above the horizon equal to your latitude. It's also the end star in the handle of the Little Dipper. Polaris is not the brightest star in the sky and may even appear dim, depending upon your sky conditions.



**Figure 7-6 Primary mirror. Large thumbscrews are for collimation and Small thumbscrews are for locking the mirror in place**

Prior to re-collimating the primary mirror, locate the collimation screws on the rear of the telescope tube. The rear cell (shown in Figure 7-6) has three large thumbscrews which are used for collimation and three small thumbscrews which are used lock the mirror in place. The collimation screws tilt the primary mirror. You will start by loosening the small locking screw a few turns each. Normally, motions on the order of an  $\frac{1}{8}$  turn will make a difference, with approximately a  $\frac{1}{2}$  to  $\frac{3}{4}$  turn being the maximum required for the large collimation screws. Turn one collimation screw at a time and with a collimation tool or eyepiece see how the collimation is affected (see the following paragraph below). It will take some experimenting but you will eventually get the centering you desire.

It is best to use the optional collimation tool or collimating eyepiece. Look into the focuser and notice if the secondary reflection has moved closer to the center of the primary mirror.

With Polaris or a bright star centered within the field of view, focus with either the standard ocular or your highest power ocular, i.e. the shortest focal length in mm, such as a 6mm or 4mm. Another option is to use a longer focal length ocular with a Barlow lens. When a star is in focus it should look like a sharp pinpoint of light. If, when focusing on the star, it is irregular in shape or appears to have a flare of light at its edge, this means your mirrors aren't in alignment. If you notice the appearance of a flare of light from the star that remains stable in location, just as you go in and out of exact focus, then re-collimation will help sharpen the image.

When satisfied with the collimation, tighten the small locking screws.

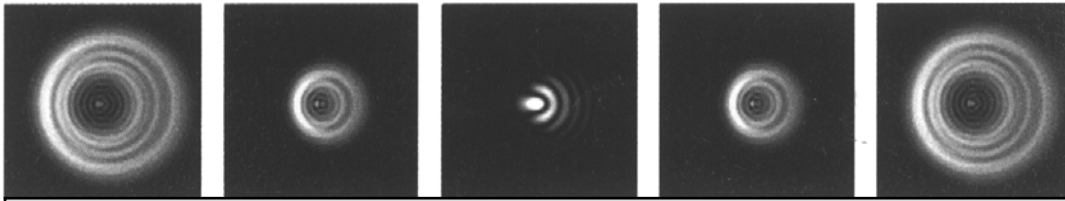

**Fig 7-7** Even though the star pattern appears the same on both sides of focus, they are asymmetric. The dark obstruction is skewed off to the left side of the diffraction pattern indicating poor collimation.

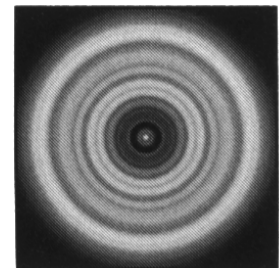

**Figure 7-8**  
A collimated telescope should appear as a symmetrical ring pattern similar to the diffraction disk seen here.

Take note of the direction the light appears to flare. For example, if it appears to flare toward the three o'clock position in the field of view, then you must move whichever screw or combination of collimation screws necessary to move the star's image toward the direction of the flaring. In this example, you would want to move the image of the star in your eyepiece, by adjusting the collimation screws, toward the three o'clock position in the field of view. It may only be necessary to adjust a screw enough to move the star's image from the center of the field of view to about halfway, or less, toward the field's edge (when using a high power ocular).

Collimation adjustments are best made while viewing the star's position in the field of view and turning the adjustment screws simultaneously. This way, you can see exactly which way the movement occurs. It may be helpful to have two people working together: one viewing and instructing which screws to turn and by how much, and the other performing the adjustments.

**IMPORTANT:** After making the first, or each adjustment, it is necessary to re-aim the telescope tube to re-center the star again in the center of the field of view. The star image can then be judged for symmetry by going just inside and outside of exact focus and noting the star's pattern. Improvement should be seen if the proper adjustments are made. Since three screws are present, it may be necessary to move at least two of them to achieve the necessary mirror movement.

## **Optional Accessories**

You will find that additional accessories for your Omni telescope will enhance your viewing pleasure and expand the usefulness of your telescope. For ease of reference, all the accessories are listed in alphabetical order. This is just a short listing of various accessories and please visit the Celestron website for complete and detailed accessories available.

**Barlow Lens** - A Barlow lens is a negative lens that increases the focal length of a telescope. Used with any eyepiece, it doubles the magnification of that eyepiece. Celestron offers two Barlow lens in the 1-1/4" size. The 2x Ultima Barlow (# 93506) is a compact triplet design that is fully multicoated for maximum light transmission and parfocal when used with the Ultima eyepieces. The OMNI Barlow (# 93326) is a compact achromatic Barlow lens that is under three inches long and weighs only 4 oz. It works very well with all Celestron eyepieces.

**Collimation Eyepiece 1 1/4"** - The collimation eyepiece (# 94182) is ideal for precise collimation of Newtonian telescopes and helpful for aligning Schmidt-Cassegrains. This special eyepiece fits into 1 1/4" focusers and diagonals.

**Eyepieces** - Like telescopes, eyepieces come in a variety of designs. Each design has its own advantages and disadvantages. Below are just some of the eyepiece series available.

- **OMNI Plössl** - Plössl eyepieces have a 4-element lens designed for low-to-high power observing. The Plössls offer razor sharp views across the entire field, even at the edges! In the 1-1/4" barrel diameter, they are available in the following focal lengths: 4mm, 6mm, 9mm, 12.5mm, 15mm, 20mm, 25mm, 32mm and 40mm.
- **X-Cel** - This 6 element design allows each X-Cel Eyepiece to have 20mm of eye relief, 55° field of view and more than 25mm of lens aperture (even with the 2.3mm). In order to maintain razor sharp, color corrected images across its 55° field of view, extra-low dispersion glass is used for the most highly curved optical elements. The excellent refractive properties of these high grade optical elements, make the X-Cel line especially well suited for high magnification planetary viewing where sharp, color-free views are most appreciated. X-Cel eyepieces come in the following focal lengths for 1 1/4" barrels: 2.3mm, 5mm, 8mm, 10mm, 12.5mm, 18mm, 21mm, 25mm.



**Filters Sets, Eyepiece** - Celestron offers four convenient filter sets, which contain four different filters per set. Not only are these highly useful filter combinations, but they also offer an economical way to add versatility to your filter collection. All fit 1 1/4" eyepieces.

Series 1 - # 94119-10  
Orange, Light Blue, ND13%T, Polarizing (#s 21, 80A, #15, Polarizing)

Series 2 - # 94119-20  
Deep Yellow, Red, Light Green, ND25% T (#s 12, 25, 56, 96ND-25)

Series 3 - # 94119-30  
Light Red, Blue, Green, ND50% T (#s 23A, 38A, 58, 96ND-50)

Series 4 - # 94119-40  
Yellow, Deep Yellow, Violet, Pale Blue (#s 8, 47, 82A, 96ND-13)

**Flashlight, Night Vision (# 93588)** - Celestron's premium model for astronomy, using two red LED's to preserve night vision better than red filters or other devices. Brightness is adjustable. Operates on a single 9 volt battery (included).

**Diagonal 2" Mirror (# 93519)** - Celestron offers a 2" 90° Mirror Diagonal to thread on Schmidt- Cassegrain telescopes or slides into the barrel of a 2" refractor focuser. This diagonal includes an adapter to accept 1¼" eyepieces. It has a multicoated mirror and smooth mechanics that are precision manufactured for reliability.

**Digital Camera Adapter – Universal (# 93626)** – A universal mounting platform that allows you to do afocal photography (photography through the eyepiece of a telescope) using 1 ¼" or 2" eyepieces with your digital camera.

**Erect Image Diagonal (#94112-A)** - This accessory is an Amici prism arrangement that allows you to look into the telescope at a 45° angle with images that are oriented properly (upright and correct from left-to-right). It is useful for daytime, terrestrial viewing with refractor and Schmidt-Cassegrain telescopes.

**Micro Guide Eyepiece (# 94171)** - This multipurpose 1 ¼" 12.5mm illuminated reticle can be used for guiding deep-sky astrophotos, measuring position angles, angular separations, and more. The laser etched reticle provides razor sharp lines and the variable brightness illuminator is completely cordless.

**Moon Filter (# 94119-A)** - Celestron's Moon Filter is an economical eyepiece filter for reducing the brightness of the moon and improving contrast, so greater detail can be observed on the lunar surface. The clear aperture is 21mm and the transmission is about 18%.

**Motor Drive, Dual Axis (# 93522)** - This dual axis motor drive, with drive corrector capabilities, is designed for Celestron's Omni CG-4 mounts. It precisely controls the telescope's tracking speed during long, timed exposures of celestial objects, producing the best possible image sharpness. Four speeds are available—1x (sidereal), 2x for guiding, 4x, and 8x for centering. These precision, state-of-the-art DC motor drives operate from 4 D-cell batteries (not included). The hand controller module is very compact and fits easily in the palm of your hand. Motors for both axes are included, along with brackets, clutches and hardware. Motor drives are a must for those with a serious interest in astrophotography or CCD imaging.

**NexImage – Solar System Imager (# 93712)** – NexImage is a complete CCD solar system imager capable of producing high quality planetary images with greater light sensitivity and color fidelity than comparable CMOS imagers. Combined with the NexImage software package, NexImage can bring out tremendous detail and reveal a final image that will rival those taken with astronomical CCD cameras costing thousands of dollars more. The 1 ¼" adapter barrel makes NexImage compatible with most any telescope. Very easy to understand operating instructions included.

**Polar Axis Finderscope (# 94221)** – This useful accessory speeds accurate polar alignment by providing a means of visually aligning your German equatorial mount with Polaris and true north. As a result, you can spend more time observing and less time setting up. The finderscope has an easy to use cross hair reticle.

**Radial Guider (# 94176)** - The Celestron Radial Guider is specifically designed for use in prime focus, deep sky astrophotography with Schmidt-Cassegrain telescopes, and takes the place of the T-Adapter. This device allows you to photograph and guide simultaneously through the optical tube assembly of your telescope. This type of guiding produces the best results since what you see through the guiding eyepiece is exactly reproduced on the processed film. The Radial Guider is a "T"-shaped assembly that attaches to the rear cell of the telescope. As light from the telescope enters the guider, most passes straight through to the camera. A small portion, however, is diverted by a prism at an adjustable angle up to the guiding eyepiece. This guider has two features not found on other off-axis guiders; first, the prism and eyepiece housing rotate independently of the camera orientation making the acquisition of a guide star quite easy. Second, the prism angle is tunable allowing you to look at guide stars on-axis. This accessory works especially well with the Reducer/Corrector.

**Reducer/Corrector (# 94175)** - This lens reduces the focal length of the telescope by 37%, making your Omni XLT127 a 788mm f/6.3 instrument. In addition, this unique lens also corrects inherent aberrations to produce crisp images all the way across the field when used visually. When used photographically, there is some vignetting that produces a 26mm circular image on the processed film. It also increases the field of view significantly and is ideal for wide-field, deep-space viewing. It is also perfect for beginning prime focus, long-exposure astrophotography when used with the radial guider. It makes guiding easier and exposures much shorter.



**SkyScout ( # 93970)** – A hand held personal planetarium that identifies and locates objects in the night sky. 6,000 object database with audio descriptions of over 200 popular objects. Comes with earphones, carrying case and strap, SD card expansion slot and USB cable.

**Sky Maps (# 93722)** - Celestron Sky Maps are the ideal teaching guide for learning the night sky. You wouldn't set off on a road trip without a road map, and you don't need to try to navigate the night sky without a map either. Even if you already know your way around the major constellations, these maps can help you locate all kinds of fascinating objects.

**T-Adapter (# 93633-A)** - T-Adapter (with additional T-Ring) allows you to attach your SLR camera to the rear cell of your Schmidt-Cassegrain telescope. This turns your telescope into a high power telephoto lens perfect for terrestrial photography and short exposure lunar and filtered solar photography.

**T-Ring** - The T-Ring couples your 35mm SLR camera body to the T-Adapter, radial guider, or tele-extender. This accessory is mandatory if you want to do photography through the telescope. Each camera make (i.e., Minolta, Nikon, Pentax, etc.) has its own unique mount and therefore, its own T-Ring. Celestron has 8 different models for 35mm cameras.

**Tele-Extender, Deluxe (# j93643)** - The tele-extender is a hollow tube that allows you to attach a camera to the Schmidt-Cassegrain telescope when the eyepiece is installed. This accessory is used for eyepiece projection photography which allows you to capture very high power views of the Sun, Moon, and planets on film. The tele-extender fits over the eyepiece onto the visual back.

**UHC/LPR Filter 1 1/4" (# 94123)** - These filters are designed to enhance your views of deep sky astronomical objects when viewed from urban areas. LPR Filters selectively reduce the transmission of certain wavelengths of light, specifically those produced by artificial lights. This includes mercury and high and low pressure sodium vapor lights. In addition, they also block unwanted natural light (sky glow) caused by neutral oxygen emission in our atmosphere.

**A full description of all Celestron accessories can be found in the Celestron Accessory Catalog (# 93685)**



# Appendix A Technical Specifications

Omni XLT Series	21088	21090	31057	11084
	Omni XLT 102	Omni XLT 120	Omni XLT 150	Omni XLT 127
Optical Design	Refractor	Refractor	Newtonian	Schmidt-Cassegrain
Aperture	102mm (4.0")	120mm (4.7")	150mm (6.0")	127mm (5.0")
Focal Length	1000mm	1000mm	750mm	1250mm
Focal Ratio	f/10	f/8.3	f/5	f/10
Optical Coatings	Starbright XLT	Starbright XLT	Starbright XLT	Starbright XLT
Finderscope	6x30	6x30	6x30	6x30
Star Diagonal	1.25"	1.25"	n/a	1.25"
Eyepiece – (std) MC 50deg FOV	25mm (40x)	25mm (40x)	25mm (30x)	25mm (50x)
Mount - Equatorial	Omni CG-4	Omni CG-4	Omni CG-4	Omni CG-4
Tripod Legs	1.75" Stainless	1.75" Stainless	1.75" Stainless	1.75" Stainless
Counterweights	3.2kg (7#) & 1.8kg (4#)	3.2kg (7#) & 1.8kg (4#)	3.2kg (7#) & 1.8kg (4#)	3.2kg (7#) & 1.8kg(4#)
Highest Useful Magnification	240x	283x	360x	300x
Lowest Useful Magnification	15x	17x	21x	18x
Limiting Stellar Magnitude	12.5	12.9	13.4	13.1
Resolution: Raleigh -arc seconds	1.36	1.19	0.92	1.1
Resolution: Dawest Limit	1.14	0.97	0.76	0.91
Light Gathering Power	212x	294x	459x	329x
Field of View - Angular w/25mm ep	1.25°	1.25°	1.67°	1.0°
Field of View - Linear w/25mm ep	66 ft. @1000yds	66 ft. @1000yds	88 ft. @1000yds	53 ft. @1000yds
Optical Tube Length	39.5" (1003mm)	40.0" (1016mm)	26.5" (673mm)	11.0" (279mm)
Optical Tube Weight	9.5 # ( 4.3kg)	12.5 # ( 5.7kg)	12.0 # (5.4kg)	6.5 # ( 3.0kg)
Mount & Counterweights - Weight	21.0 # ( 9.5kg)	21.0 # ( 9.5kg)	21.0 # ( 9.5kg)	21.0 # ( 9.5kg)
Tripod Weight	12.5 # ( 5.7kg)	12.5 # (5.7kg)	12.5 # ( 5.7kg)	12.5 # ( 5.7kg)
Total Weight	43.0 # ( 19.5kg)	46.0 # ( 20.9kg)	45.5 # (20.6kg)	40.0 # (18.1kg)

## Appendix B - Glossary of Terms

### A -

Absolute magnitude	The apparent magnitude that a star would have if it were observed from a standard distance of 10 parsecs, or 32.6 light-years. The absolute magnitude of the Sun is 4.8. at a distance of 10 parsecs, it would just be visible on Earth on a clear moonless night away from surface light.
Airy disk	The apparent size of a star's disk produced even by a perfect optical system. Since the star can never be focused perfectly, 84 per cent of the light will concentrate into a single disk, and 16 per cent into a system of surrounding rings.
Alt-Azimuth Mounting	A telescope mounting using two independent rotation axis allowing movement of the instrument in Altitude and Azimuth.
Altitude	In astronomy, the altitude of a celestial object is its Angular Distance above or below the celestial horizon.
Aperture	the diameter of a telescope's primary lens or mirror; the larger the aperture, the greater the telescope's light-gathering power.
Apparent Magnitude	A measure of the relative brightness of a star or other celestial object as perceived by an observer on Earth.
Arcminute	A unit of angular size equal to 1/60 of a degree.
Arcsecond	A unit of angular size equal to 1/3,600 of a degree (or 1/60 of an arcminute).
Asterism	A small unofficial grouping of stars in the night sky.
Asteroid	A small, rocky body that orbits a star.
Astrology	The pseudoscientific belief that the positions of stars and planets exert an influence on human affairs; astrology has nothing in common with astronomy.
Astronomical unit (AU)	The distance between the Earth and the Sun. It is equal to 149,597,900 km., usually rounded off to 150,000,000 km.
Aurora	The emission of light when charged particles from the solar wind slams into and excites atoms and molecules in a planet's upper atmosphere.
Azimuth	The angular distance of an object eastwards along the horizon, measured from due north, between the astronomical meridian (the vertical line passing through the center of the sky and the north and south points on the horizon) and the vertical line containing the celestial body whose position is to be measured. .

### B -

Binary Stars	Binary (Double) stars are pairs of stars that, because of their mutual gravitational attraction, orbit around a common Center of Mass. If a group of three or more stars revolve around one another, it is called a multiple system. It is believed that approximately 50 percent of all stars belong to binary or multiple systems. Systems with individual components that can be seen separately by a telescope are called visual binaries or visual multiples. The nearest "star" to our solar system, Alpha Centauri, is actually our nearest example of a multiple star system, it consists of three stars, two very similar to our Sun and one dim, small, red star orbiting around one another.
--------------	---

### C -

Celestial Equator	The projection of the Earth's equator on to the celestial sphere. It divides the sky into two equal hemispheres.
Celestial pole	The imaginary projection of Earth's rotational axis north or south pole onto the celestial sphere.
Celestial Sphere	An imaginary sphere surrounding the Earth, concentric with the Earth's center.
Collimation	The act of putting a telescope's optics into perfect alignment.

### D -

Declination (DEC)	The angular distance of a celestial body north or south of the celestial equator. It may be said to correspond to latitude on the surface of the Earth.
-------------------	---

### E -

Ecliptic	The projection of the Earth's orbit on to the celestial sphere. It may also be defined as "the apparent yearly path of the Sun against the stars".
Equatorial mount	A telescope mounting in which the instrument is set upon an axis which is parallel to the axis of the Earth; the angle of the axis must be equal to the observer's latitude.

### F -

Focal length	The distance between a lens (or mirror) and the point at which the image of an object at infinity is brought to focus. The focal length divided by the aperture of the mirror or lens is termed the focal ratio.
<b>J -</b>	
Jovian Planets	Any of the four gas giant planets that are at a greater distance from the sun than the terrestrial planets.
<b>K -</b>	
Kuiper Belt	A region beyond the orbit of Neptune extending to about 1000 AU which is a source of many short period comets.
<b>L -</b>	
Light-Year (LY)	A light-year is the distance light traverses in a vacuum in one year at the speed of 299,792 km/ sec. With 31,557,600 seconds in a year, the light-year equals a distance of 9.46 X 1 trillion km (5.87 X 1 trillion mi).
<b>M -</b>	
Magnitude	Magnitude is a measure of the brightness of a celestial body. The brightest stars are assigned magnitude 1 and those increasingly fainter from 2 down to magnitude 5. The faintest star that can be seen without a telescope is about magnitude 6. Each magnitude step corresponds to a ratio of 2.5 in brightness. Thus a star of magnitude 1 is 2.5 times brighter than a star of magnitude 2, and 100 times brighter than a magnitude 5 star. The brightest star, Sirius, has an apparent magnitude of -1.6, the full moon is -12.7, and the Sun's brightness, expressed on a magnitude scale, is -26.78. The zero point of the apparent magnitude scale is arbitrary.
Meridian	A reference line in the sky that starts at the North celestial pole and ends at the South celestial pole and passes through the zenith. If you are facing South, the meridian starts from your Southern horizon and passes directly overhead to the North celestial pole.
Messier	A French astronomer in the late 1700's who was primarily looking for comets. Comets are hazy diffuse objects and so Messier cataloged objects that were not comets to help his search. This catalog became the Messier Catalog, M1 through M110.
<b>N -</b>	
Nebula	Interstellar cloud of gas and dust. Also refers to any celestial object that has a cloudy appearance.
North Celestial Pole	The point in the Northern hemisphere around which all the stars appear to rotate. This is caused by the fact that the Earth is rotating on an axis that passes through the North and South celestial poles. The star Polaris lies less than a degree from this point and is therefore referred to as the "Pole Star".
Nova	Although Latin for "new" it denotes a star that suddenly becomes explosively bright at the end of its life cycle.
<b>O -</b>	
Open Cluster	One of the groupings of stars that are concentrated along the plane of the Milky Way. Most have an asymmetrical appearance and are loosely assembled. They contain from a dozen to many hundreds of stars.
<b>P -</b>	
Parallax	Parallax is the difference in the apparent position of an object against a background when viewed by an observer from two different locations. These positions and the actual position of the object form a triangle from which the apex angle (the parallax) and the distance of the object can be determined if the length of the baseline between the observing positions is known and the angular direction of the object from each position at the ends of the baseline has been measured. The traditional method in astronomy of determining the distance to a celestial object is to measure its parallax.
Parfocal	Refers to a group of eyepieces that all require the same distance from the focal plane of the telescope to be in focus. This means when you focus one parfocal eyepiece all the other parfocal eyepieces, in a particular line of eyepieces, will be in focus.
Parsec	The distance at which a star would show parallax of one second of arc. It is equal to 3.26 light-years, 206,265 astronomical units, or 30,800,000,000,000 km. (Apart from the Sun, no star lies within one parsec of us.)
Point Source	An object which cannot be resolved into an image because it is too far away or too small is considered a point source. A planet is far away but it can be resolved as a disk. Most stars cannot be resolved as disks, they are too far away.
<b>R -</b>	
Reflector	A telescope in which the light is collected by means of a mirror.

Resolution	The minimum detectable angle an optical system can detect. Because of diffraction, there is a limit to the minimum angle, resolution. The larger the aperture, the better the resolution.
Right Ascension: (RA)	The angular distance of a celestial object measured in hours, minutes, and seconds along the Celestial Equator eastward from the Vernal Equinox.
<b>S -</b>	
Schmidt Telescope	Rated the most important advance in optics in 200 years, the Schmidt telescope combines the best features of the refractor and reflector for photographic purposes. It was invented in 1930 by Bernhard Voldemar Schmidt (1879-1935).
Sidereal Rate	This is the angular speed at which the Earth is rotating. Telescope tracking motors drive the telescope at this rate. The rate is 15 arc seconds per second or 15 degrees per hour.
<b>T -</b>	
Terminator	The boundary line between the light and dark portion of the moon or a planet.
<b>U -</b>	
Universe	The totality of astronomical things, events, relations and energies capable of being described objectively.
<b>V -</b>	
Variable Star	A star whose brightness varies over time due to either inherent properties of the star or something eclipsing or obscuring the brightness of the star.
<b>W -</b>	
Waning Moon	The period of the moon's cycle between full and new, when its illuminated portion is decreasing.
Waxing Moon	The period of the moon's cycle between new and full, when its illuminated portion is increasing.
<b>Z -</b>	
Zenith	The point on the Celestial Sphere directly above the observer.
Zodiac	The zodiac is the portion of the Celestial Sphere that lies within 8 degrees on either side of the Ecliptic. The apparent paths of the Sun, the Moon, and the planets, with the exception of some portions of the path of Pluto, lie within this band. Twelve divisions, or signs, each 30 degrees in width, comprise the zodiac. These signs coincided with the zodiacal constellations about 2,000 years ago. Because of the Precession of the Earth's axis, the Vernal Equinox has moved westward by about 30 degrees since that time; the signs have moved with it and thus no longer coincide with the constellations.

# January - February Sky

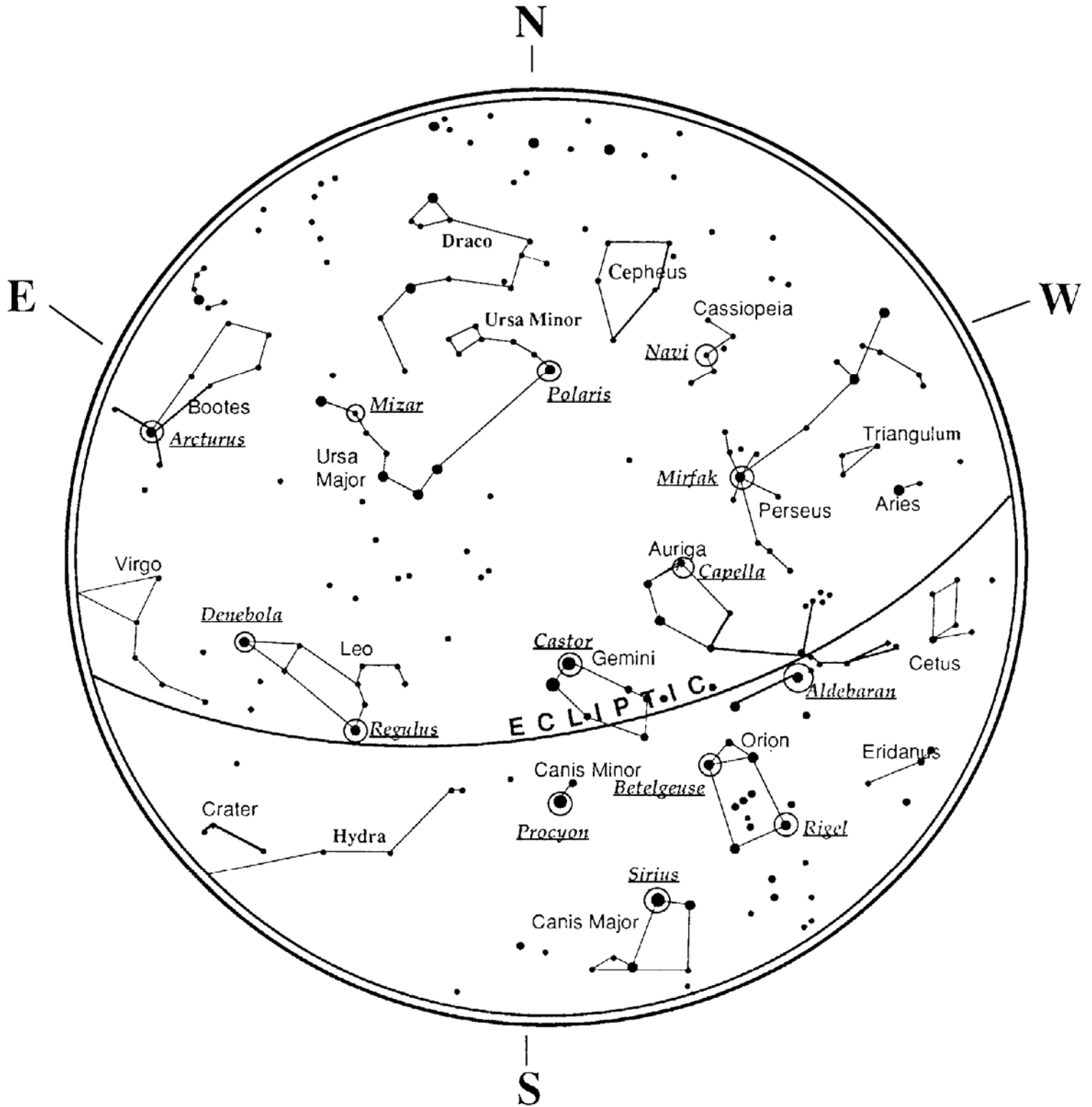

# March - April Sky

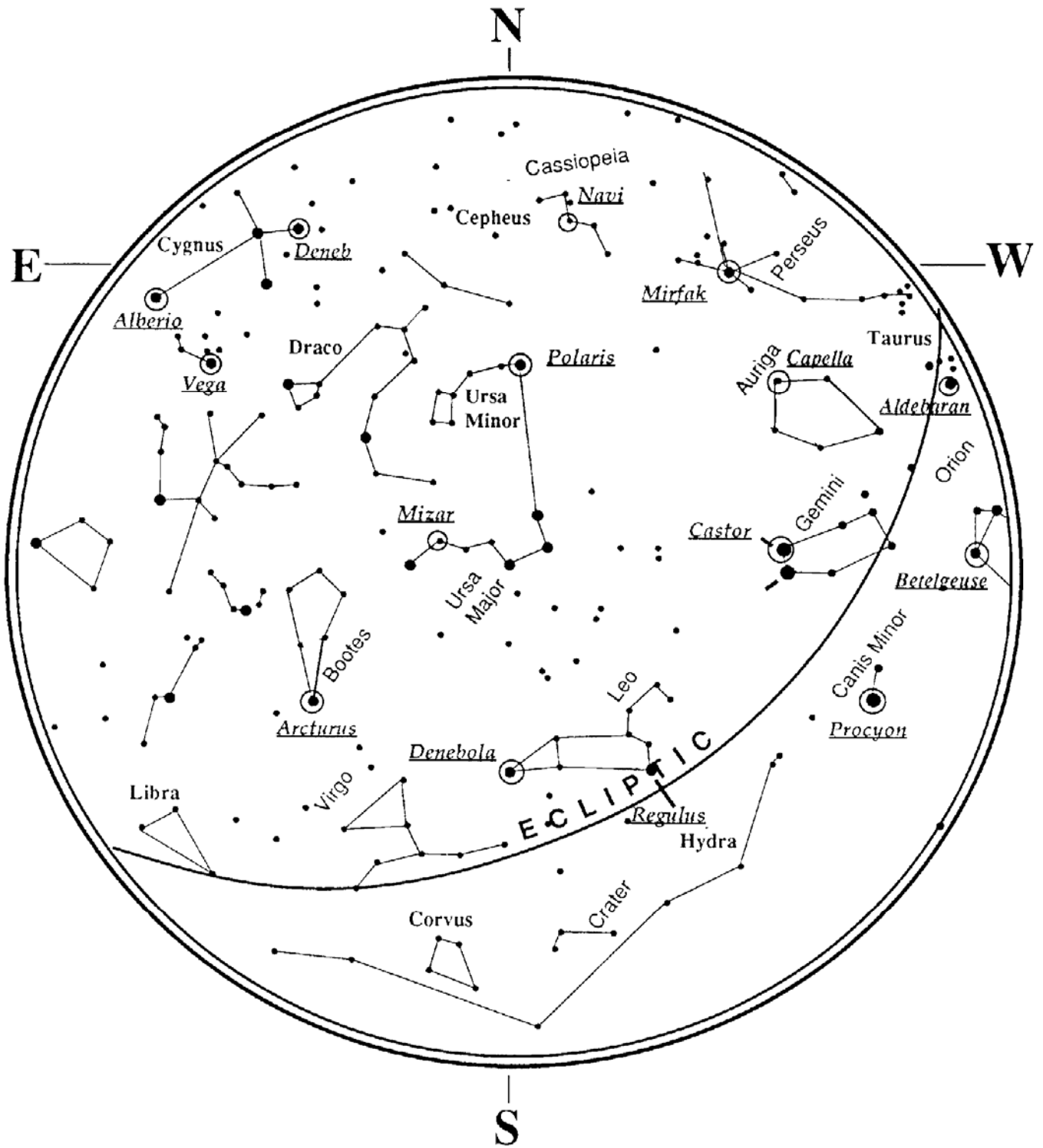

# May - June Sky

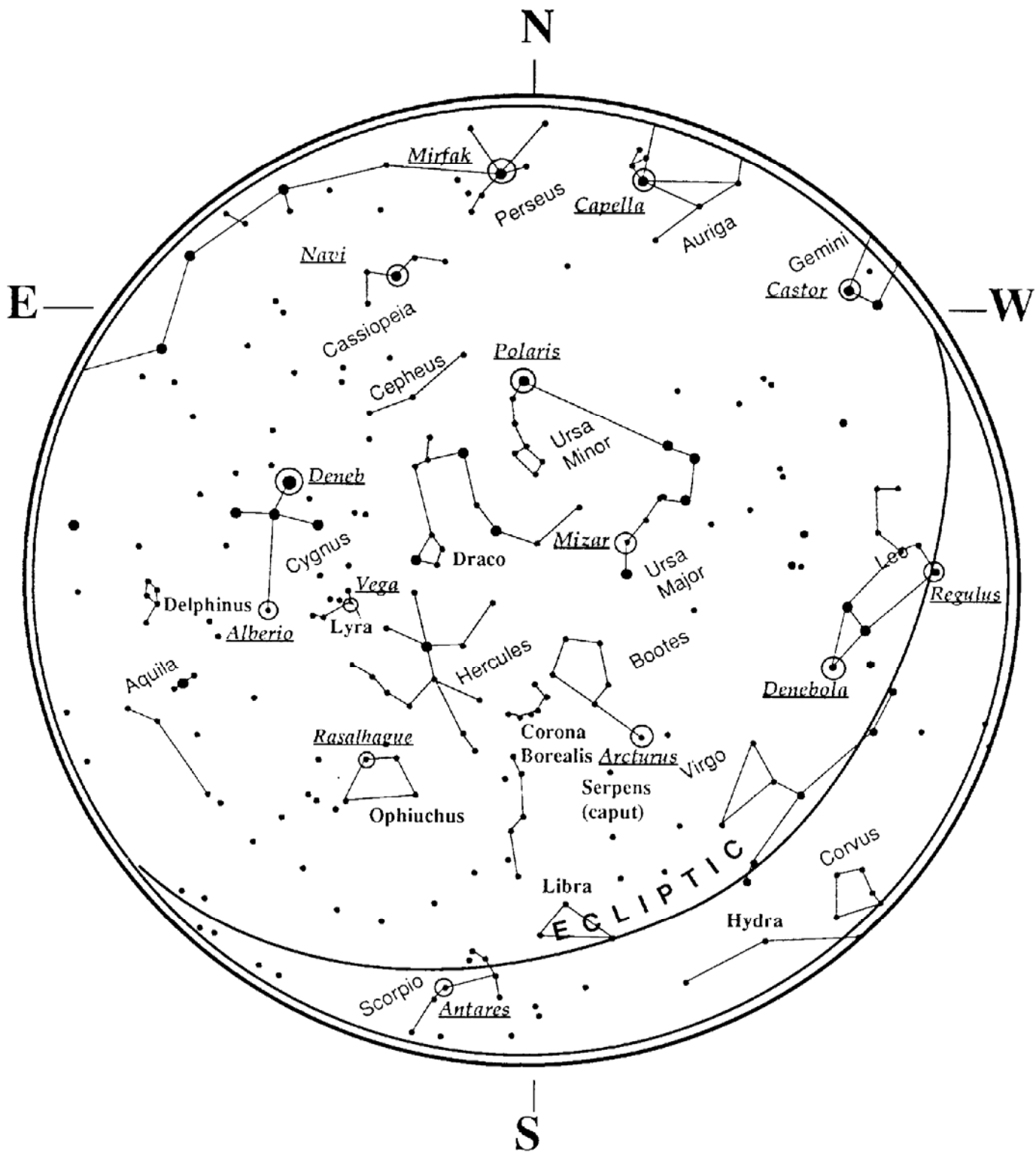

# July - August Sky

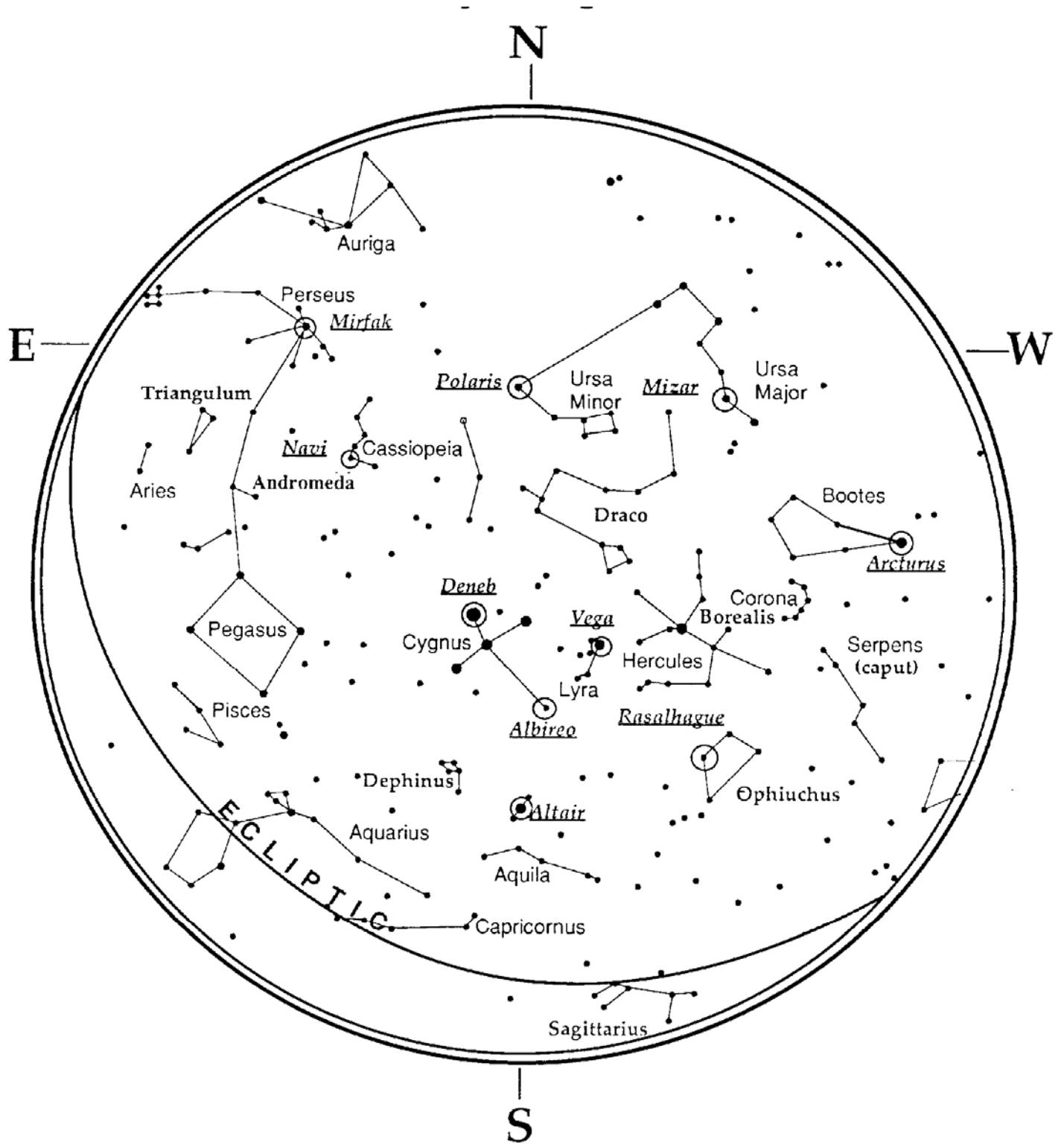



# September - October Sky

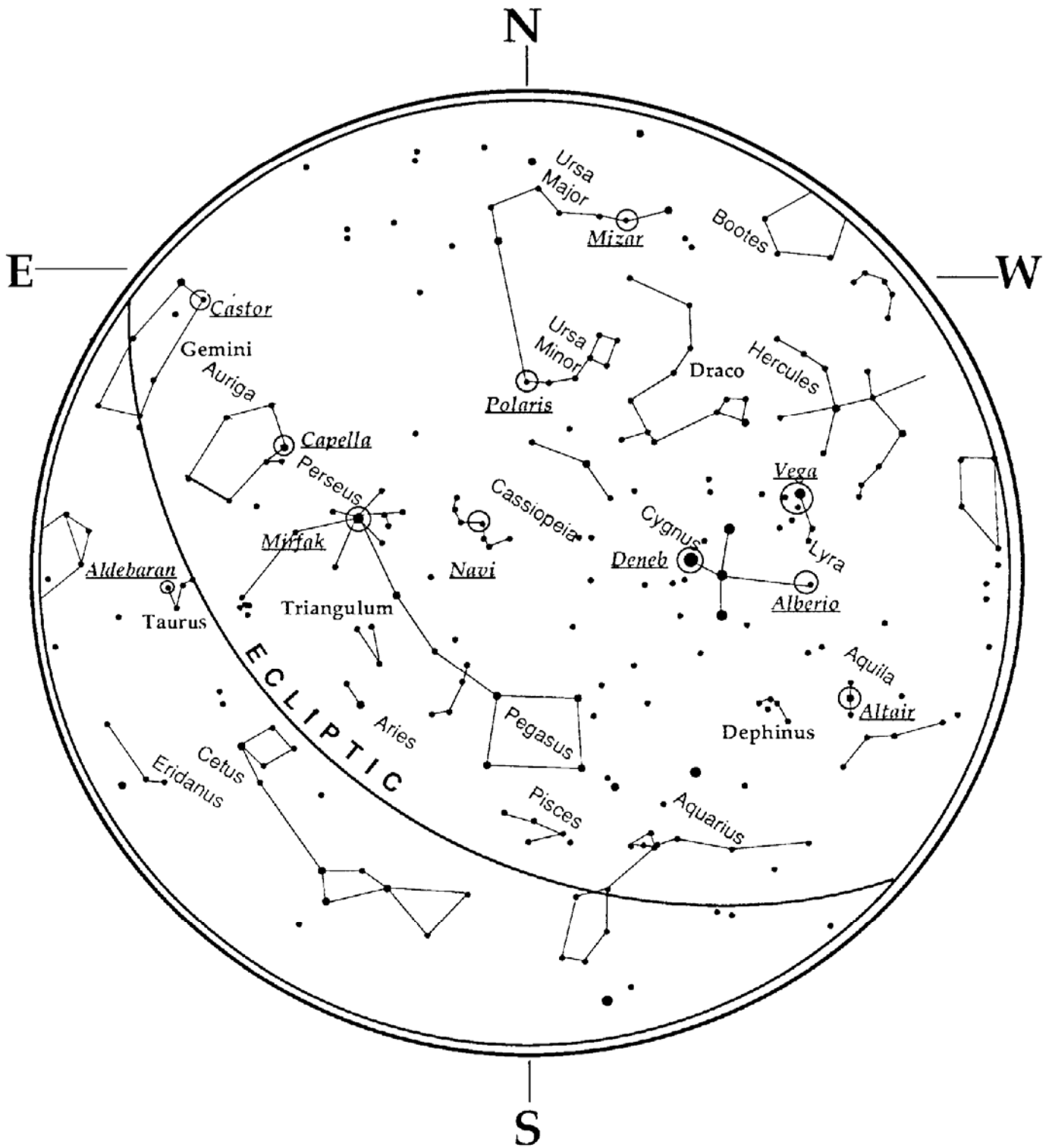

# November - December Sky

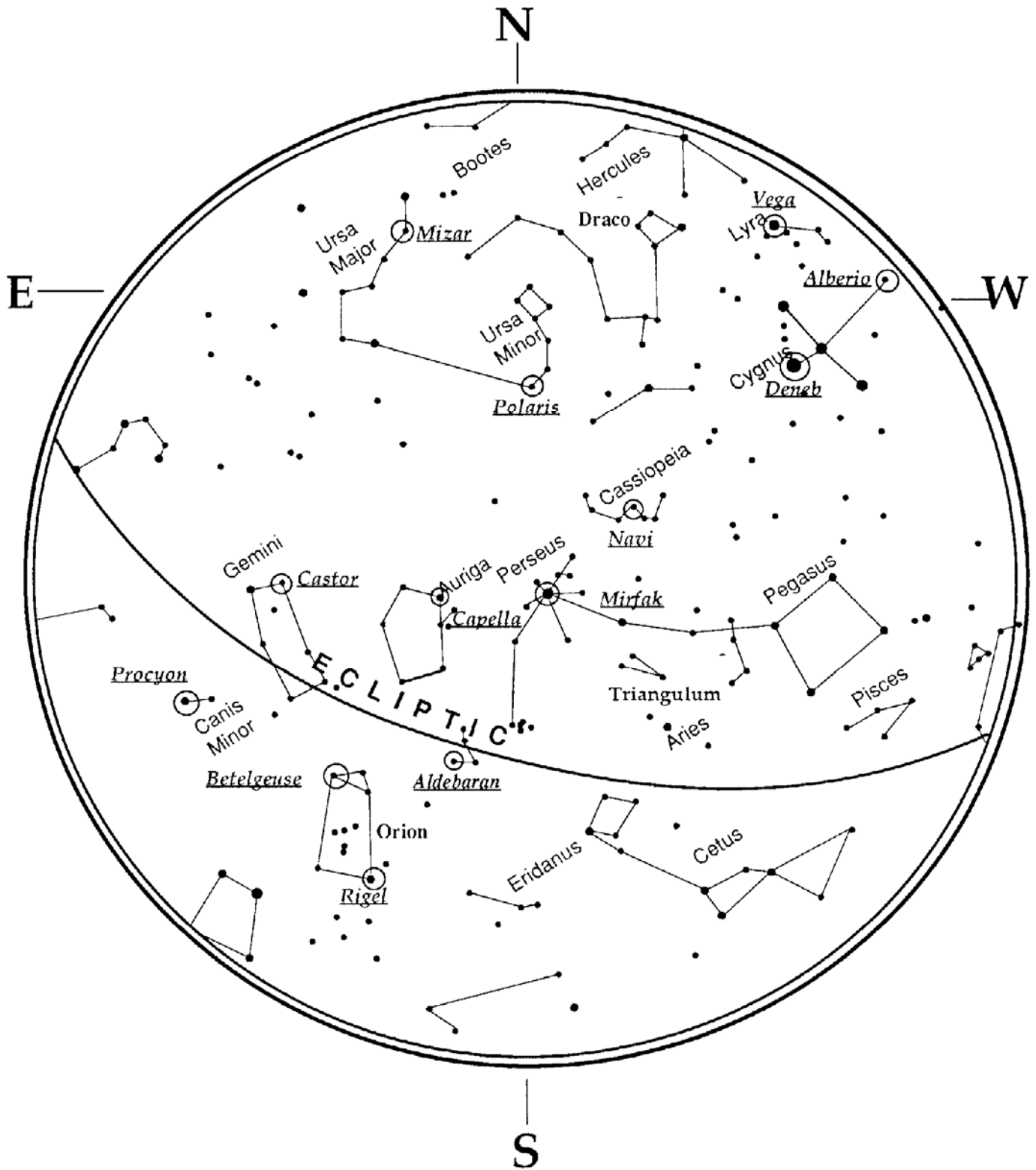

# Celestron Two Year Warranty

- A. Celestron warrants this telescope to be free from defects in materials and workmanship for two years. Celestron will repair or replace such product or part thereof which, upon inspection by Celestron, is found to be defective in materials or workmanship. As a condition to the obligation of Celestron to repair or replace such product, the product must be returned to Celestron together with proof-of-purchase satisfactory to Celestron.
- B. The Proper Return Authorization Number must be obtained from Celestron in advance of return. Call Celestron at (310) 328-9560 to receive the number to be displayed on the outside of your shipping container.

All returns must be accompanied by a written statement setting forth the name, address, and daytime telephone number of the owner, together with a brief description of any claimed defects. Parts or product for which replacement is made shall become the property of Celestron.

**The customer shall be responsible for all costs of transportation and insurance, both to and from the factory of Celestron, and shall be required to prepay such costs.**

Celestron shall use reasonable efforts to repair or replace any telescope covered by this warranty within thirty days of receipt. In the event repair or replacement shall require more than thirty days, Celestron shall notify the customer accordingly. Celestron reserves the right to replace any product which has been discontinued from its product line with a new product of comparable value and function.

**This warranty shall be void and of no force of effect in the event a covered product has been modified in design or function, or subjected to abuse, misuse, mishandling or unauthorized repair. Further, product malfunction or deterioration due to normal wear is not covered by this warranty.**

CELESTRON DISCLAIMS ANY WARRANTIES, EXPRESS OR IMPLIED, WHETHER OF MERCHANTABILITY OF FITNESS FOR A PARTICULAR USE, EXCEPT AS EXPRESSLY SET FORTH HEREIN.

THE SOLE OBLIGATION OF CELESTRON UNDER THIS LIMITED WARRANTY SHALL BE TO REPAIR OR REPLACE THE COVERED PRODUCT, IN ACCORDANCE WITH THE TERMS SET FORTH HEREIN. CELESTRON EXPRESSLY DISCLAIMS ANY LOST PROFITS, GENERAL, SPECIAL, INDIRECT OR CONSEQUENTIAL DAMAGES WHICH MAY RESULT FROM BREACH OF ANY WARRANTY, OR ARISING OUT OF THE USE OR INABILITY TO USE ANY CELESTRON PRODUCT. ANY WARRANTIES WHICH ARE IMPLIED AND WHICH CANNOT BE DISCLAIMED SHALL BE LIMITED IN DURATION TO A TERM OF TWO YEARS FROM THE DATE OF ORIGINAL RETAIL PURCHASE.

Some states do not allow the exclusion or limitation of incidental or consequential damages or limitation on how long an implied warranty lasts, so the above limitations and exclusions may not apply to you.

This warranty gives you specific legal rights, and you may also have other rights which vary from state to state.

Celestron reserves the right to modify or discontinue, without prior notice to you, any model or style telescope.

If warranty problems arise, or if you need assistance in using your telescope contact:

**Celestron**  
Customer Service Department  
2835 Columbia Street  
Torrance, CA 90503 U.S.A.  
Tel. (310) 328-9560  
Fax. (310) 212-5835  
Monday-Friday 8AM-4PM PST

This warranty supersedes all other product warranties.

**NOTE: This warranty is valid to U.S.A. and Canadian customers who have purchased this product from an Authorized Celestron Dealer in the U.S.A. or Canada. Warranty outside the U.S.A. and Canada is valid only to customers who purchased from a Celestron Distributor or Authorized Celestron Dealer in the specific country and please contact them for any warranty service.**



Celestron  
2835 Columbia Street  
Torrance, CA 90503 U.S.A.  
Tel. (310) 328-9560  
Fax. (310) 212-5835  
Web site at <http://www.celestron.com>

Copyright 2007 Celestron  
All rights reserved.

(Products or instructions may change  
without notice or obligation.)

Item # 21088-INST  
Printed in China  
\$10.00  
01-07